

ADA Notice

For individuals with sensory disabilities, this document is available in alternate formats. For information call (916) 654-6410 or TDD (916) 654-3880 or write Records and Forms Management, 1120 N Street, MS-89, Sacramento, CA 95814.

1. REPORT NUMBER CA19-2761	2. GOVERNMENT ASSOCIATION NUMBER	3. RECIPIENT'S CATALOG NUMBER
4. TITLE AND SUBTITLE Performance Measures for Roadside Features		5. REPORT DATE 09/10/2018
7. AUTHORS Patricia B. Fyhrie, Ankyd Ji & Bahram Ravani, Principal Investigator		6. PERFORMING ORGANIZATION CODE AHMCT Research Center, UC Davis
9. PERFORMING ORGANIZATION NAME AND ADDRESS AHMCT Research Center UCD Dept. of Mechanical & Aerospace Engineering Davis, California 95616-5294		8. PERFORMING ORGANIZATION REPORT NO. UCD-ARR-18-09-10-01
12. SPONSORING AGENCY AND ADDRESS California Department of Transportation P.O. Box 942873, MS #83 Sacramento, CA 94273-0001		10. WORK UNIT NUMBER
15. SUPPLEMENTARY NOTES		11. CONTRACT OR GRANT NUMBER 65A0560, Task ID 2761
16. ABSTRACT There are over 15,000 centerline miles of highways in the state of California with Caltrans Division of Maintenance performing upkeep operations for the roadways and the accompanying roadside features, including items such as guardrails, signs, landscaping, storm water management systems, and traffic signals. Experienced maintenance workers who have detailed knowledge of their home base roadways have accumulated a wealth of knowledge on the pros and cons of the design and implementation of roadside features of all types. In an effort to improve the safety and the work conditions of maintenance workers, meetings with these roadway experts throughout the state were conducted to capture their ideas on how to improve the design and implementation of roadside features. The objective of this research was to identify critical roadside features that have recurring maintenance needs or those whose maintenance would expose workers to high-risk environments, such as those within 30 feet of high-speed traffic. This research study has identified such critical roadside features and have made recommendations on the need for policy change, or for additional training, or for further research. Such additional research can include life cycle analyses methods considering maintenance resources and worker's time exposure to traffic. The benefits of this research study includes providing support for potential policy change to emphasize maintainability with the goal of increased worker safety as well as recommendations for updates and additions to the Highway Design and Maintenance Manuals and Training that can have positive impacts on worker safety.		13. TYPE OF REPORT AND PERIOD COVERED Final Report 4/1/2017 – 09/30/2018
17. KEYWORDS Roadside Features, Guardrails, Signs, Landscaping, Storm Water, Traffic Signals		14. SPONSORING AGENCY CODE Caltrans
19. SECURITY CLASSIFICATION (of this report) Unclassified		18. DISTRIBUTION STATEMENT No restrictions. This document is available to the public through the National Technical Information Service, Springfield, Virginia 22161.
20. NUMBER OF PAGES 78		21. COST OF REPORT CHARGED

Reproduction of completed page authorized

DISCLAIMER

The research reported herein was performed by the Advanced Highway Maintenance and Construction Technology (AHMCT) Research Center, within the Department of Mechanical and Aerospace Engineering at the University of California – Davis, for the Division of Research, Innovation and System Information (DRISI) at the California Department of Transportation. AHMCT and DRISI work collaboratively to complete valuable research for the California Department of Transportation.

The contents of this report reflect the views of the author(s) who is (are) responsible for the facts and the accuracy of the data presented herein. The contents do not necessarily reflect the official views or policies of the STATE OF CALIFORNIA or the FEDERAL HIGHWAY ADMINISTRATION. This report does not constitute a standard, specification, or regulation. This report does not constitute an endorsement by the Department of any products or services described herein.

The contents of this report do not necessarily reflect the official views or policies of the University of California. This report does not constitute an endorsement by the University of California of any products or services described herein.

For individuals with sensory disabilities, this document is available in alternate formats. For information, call (916) 654-8899, TTY 711, or write to the California Department of Transportation, Division of Research, Innovation and System Information, MS-83, P.O. Box 942873, Sacramento, CA 94273-0001.



**Advanced Highway Maintenance
and Construction Technology
Research Center**

Department of Mechanical and Aerospace Engineering
University of California at Davis

Performance Measures for Roadside Features

Patricia B. Fyhrie, Ankyd Ji &
Bahram Ravani, Principal Investigator

Report Number: CA19-2761

AHMCT Research Report: UCD-ARR-18-09-10-01

Final Report of Contract: 65A0560, Task ID 2761

September 10, 2018

California Department of Transportation

Division of Research, Innovation and System Information

ABSTRACT

There are over 15,000 centerline miles of highways in the state of California with Caltrans Division of Maintenance performing upkeep operations for the roadways and the accompanying roadside features, including items such as guardrails, signs, landscaping, storm water management systems, and traffic signals. Experienced maintenance workers who have detailed knowledge of their home base roadways have accumulated a wealth of knowledge on the pros and cons of the design and implementation of roadside features of all types. In an effort to improve the safety and the work conditions of maintenance workers, meetings with these roadway experts throughout the state were conducted to capture their ideas on how to improve the design and implementation of roadside features. The objective of this research was to identify critical roadside features that have recurring maintenance needs or those whose maintenance would expose workers to high-risk environments, such as those within 30 feet of high-speed traffic. This research study has identified such critical roadside features and have made recommendations on the need for policy change, or for additional training, or for further research. Such additional research can include life cycle analyses methods considering maintenance resources and worker's time exposure to traffic. The benefits of this research study includes providing support for potential policy change to emphasize maintainability with the goal of increased worker safety as well as recommendations for updates and additions to the Highway Design and Maintenance Manuals and Training that can have positive impacts on worker safety.

EXECUTIVE SUMMARY

Research Objectives and Methodology

This research study developed a list of specific roadside features that have a significant impact on worker safety due to roadside exposure through time and location. The objective was to identify critical roadside features with recurring maintenance needs or those whose maintenance would expose workers to high-risk environments, such as those within 30 feet of high-speed traffic. The methodology used involved combining a literature search with information gathered from people who perform the actual maintenance work at their home base. The approach identified existing Caltrans policies, design guidance, manuals, plans, and specifications for roadside features. The method also captured from field personnel ideas on how to improve the design and implementation of roadside features to improve their maintainability.

The goal was to help Caltrans develop revised policy documents that modernize highway design and operational practices to provide for increased worker safety. This goal is achieved by providing supporting data and information necessary to make changes.

Results and Recommendations

This research identified roadside features requiring “high maintenance” as a function of frequency and difficulty of maintenance as well as worker’s exposure time to high-speed traffic. In general, it is felt that “maintainability” is not considered in the design and cost assessment of roadside features. If maintenance resources were included in the design and selection of roadside features, then many features would be designed or selected differently. The outcome of this research was to identify these roadside features and recommend policy change or the need for training and possibly further research and development.

The following roadside features were identified as having the most significant impact regarding the maintenance functions:

- Guardrails and Barriers
- End Treatments
- Landscaping and Irrigation
- Storm Water Mechanisms
- Signs and Poles
- Sound Walls
- Fencing
- Electrical

The following are some of the main recommendations of this research study:

On Guardrails

- Research is needed to develop a methodology for life cycle assessment that can be used to provide a basis for policy revisions that would allow proper selection between metal guardrails and concrete barriers as well as wooden guardrail posts versus metal posts.

Performance Measures for Roadside Features

- It is recommended that revised criteria be developed for the installation specifications and inspection protocols of ground treatments near guardrails to alleviate the performance problems with ground treatments.
- Information on maintenance of guardrails with Patina finish should be distributed to field workers and districts. This can be done by adding the information to the Maintenance Manual or through a news article.

On End Treatments, Landscaping and Irrigation

- More research is recommended for maintenance issues that are “broad in scope” such as end treatments and Landscaping.
- For placement of irrigation systems, it is recommended to have additional training and education for the field operations so that existing policies are fully followed.

On Storm Water Mechanisms

- It is recommended that a new policy is developed by Design, Maintenance, and possibly the Hydrology department to discourage the use of slotted drains.
- More research is recommended to address maintenance issues surrounding drainage access and Gross Solid Removal Devices (GSRD).
- In relationship to “smart” pump houses, it is recommended that information be shared among districts so that those with experience can help others utilize electronic signals to notify the Traffic Monitoring Center (TMC) when a malfunction occurs.

On Signs and Posts

- Research is a need for a cost benefit analysis evaluating the use of steel posts versus wooden posts for signs that would consider maintenance and disposal as part of the life cycle cost.
- It is recommended that a new policy be developed to produce sign assets that are all modular.
- There exists a policy memo related to positioning of signs which governs G-84 signs in the exit gore and alternative signage. Additional training is recommended to uphold the current policy governing the use/maintenance of signs placed in the CRZ.
- With respect to anti-graffiti treatments on signs, there is a new “Type 11” reflective coating in place with no knowledge of its anti-graffiti performance. It is recommended that appropriate Maintenance and Traffic OPS group evaluate the anti-graffiti effects of this new type of coating for signs.

Performance Measures for Roadside Features

- A new policy is recommended to have Design, Structures, and/or Construction adopt the “Quick Change” type of signs with supporting sleeves. Districts 4 and 5 already use “quick change” sleeves and posts.

On Sound Walls

- A policy change is recommended for sound wall placement that can eliminate or reduce the problem associated with leaving land behind the sound wall. The new policy should be developed by collaboration between appropriate groups from Design and the “Right of Way.”

On Fencing

- It is recommended to use alternative fencing with finer mesh and anti-cutting razor wire and to tag or mark the fencing to prevent resale. Furthermore, improvements for access to the location that can address security is recommended.

On Electricals

- It is recommended to consider use of aluminum versus copper wiring in hot spots due to lower cost of aluminum.
- Electrical boxes can be welded to prevent unwanted access; but the life cycle outcome of welding should be evaluated due to its adverse effects on maintenance access.
- Use of tracers or markings for wiring should be considered to prevent stealing and reselling.
- It is recommended to learn and adapt for security of electricals what districts 6 and 10 have developed on encasing valve boxes or fencing around their irrigation components.

Overall Recommendations for Worker Safety:

- Minimizing high labor-intensive maintenance which is done near high-speed traffic should be a key objective for safety.
- Offsetting worker placement as far away from active travel lanes needs to be maximized.
- Identifying roadway areas where maintenance workers will have a high-risk in maintaining roadside features will be useful so that plans can be considered to improve conditions.
- Factoring-in additional risks to labor and maintenance costs when performing cost-benefit analyses.
- Increasing shoulder width to provide more access and improve worker placement for maintenance functions when appropriate.

Performance Measures for Roadside Features

- Safety in litter and debris removal operations should be addressed as a separate issue from landscaping.

TABLE OF CONTENTS

Abstract..... *ii*

Executive Summary *iii*

Research Objectives and Methodology**iii**

Results and Recommendations**iii**

Table of Contents *vii*

List of Figures *ix*

List of Tables *x*

List of Acronyms and Abbreviations *xi*

Acknowledgments..... *xii*

Chapter 1: Introduction **13**

Problem and Background **13**

Objectives..... **13**

Scope..... **13**

Overview of Research Results and Benefits..... **13**

Chapter 2: Literature Review **15**

Clear Recovery Zone (CRZ) **15**

Barriers and Guardrails **18**

Landscaping and Irrigation **22**

Storm Water and Trash Capture Devices **27**

Sound Walls..... **29**

Signs **31**

Fencing and Access Issues **33**

Electrical **35**

Chapter 3: Caltrans Database Resources **37**

IMMS **37**

Traffic Collision Report Data **47**

Lane Closure System **50**

Enterprise **51**

Integrating all the Codes **52**

Chapter 4: Identified Roadside Features **53**

Meetings with District Maintenance Personnel..... **53**

Synthesis of Roadside Features Maintainability	54
<i>PROJECT PLANNING Group Considerations.....</i>	62
Metal Beam vs. Concrete Guardrail.....	62
Metal vs. Wooden Posts	63
Ground Treatments	63
Natina Guardrails	63
End Treatments.....	63
Median Design.....	63
Landscape Offset.....	63
Hardscaping vs. Landscaping, Litter and Debris, Median Planting and Design, Homeless Deterrent, Tree and Shrub Placement.....	64
Rock Blanket	64
Irrigation Placement	64
Roundabouts.....	64
Slotted Drains	64
Drainage Access and GSRDs.....	64
Smart Pump Houses.....	64
Sound Walls.....	64
Sign Posts: Wood vs. Steel.....	65
Modularity of Sign Assets.....	65
Moving Signs Out of CRZ	65
Anti-Graffiti.....	65
Quick Change Sign Base (Sleeves).....	65
<i>Chapter 5: Conclusions and recommendations</i>	66
Future Work.....	73
<i>References</i>	75

LIST OF FIGURES

Figure 2.1: Clear Recovery Zone Recommendations from AASHTO Roadside Design Guide (units in feet) [1].16

Figure 2.2: Standard Plan RS1 for Roadside Signs [5].17

Figure 2.3: Equal Severity Curve for Guardrails from [3].19

Figure 2.4: AASHTO Roadside Design Guide Design Chart for Embankment Barrier Consideration [7]......20

Figure 2.5: Standard Plan RSP A76A for Concrete Barrier Type 60M [5]......21

Figure 2.6: Standard Plan RSP A77L1 Midwest Guardrail System [5].21

Figure 2.7: FDOT Standard Plan for Concrete Barrier Wall [23]......22

Figure 2.8: Caltrans PS&E Sight Distance Setback Example [25]......25

Figure 2.9: NDOT Structures and Hardscaping Treatments for I-15 Corridor [31].26

Figure 2.10: Standard Plan D98B for Slotted Corrugated Steel Pipe Drain [5].28

Figure 2.11: Georgia DOT Inspection Checklist for Manholes, Junction Boxes, Catch Basins, and Inlets [37].29

Figure 2.12: Standard Plan B15-1 for Sound Wall Masonry Block on Footing Detail [5].31

Figure 2.13: Destination Sign Specification G1-1 [43]......32

Figure 2.14: Standard Plan RS1 Roadside Sign Typical Installation [5]......33

Figure 2.15: Standard Plan RSP A85 for Chain Link Fence [5].34

Figure 2.16: Florida DOT Standard Plan for Type B Fence [23]......35

Figure 2.17: Standard Plan RSP ES-9C for Structure Pull Box [5]......36

Figure 3.1: Work Orders Completed for Each District for Fiscal Year of 2017......39

Figure 3.2: LEMO Costs for Barrier Related Activities.43

Figure 3.3: LEMO Costs for Sign Related Activities......44

Figure 3.4: LEMO Costs for Litter Related Activities.45

Figure 3.5: LEMO Costs for Storm Water Related Activities.45

Figure 3.6: LEMO Costs for Landscaping Related Activities.46

Figure 3.7: LEMO Costs for Guardrails, Sound Walls, End Treatments, Fencing, and Graffiti.46

Figure 3.8: Bar chart of collision types for 2016 along with their associated fatalities and injury distribution.48

Figure 3.9: Excerpt from a Traffic Collision Report Form where the attending CHP officer indicates the “Type of Collision” and the “Motor Vehicle Involved With” designation for the collision......49

Figure 3.10: Distribution of Object Descriptions when the Primary Vehicle is involved with a "Fixed Object." This narrative description of the object is denoted in the Traffic Collision Report......49

LIST OF TABLES

Table 2.1: Horizontal Curve Adjustment Factor for CRZ from New York HDM [15]	18
Table 2.2: Large Tree Setback Requirements on Conventional Highways [2]	23
Table 2.3: Sight Distance Standards from HDM 200 [2]	24
Table 2.4: Noise Abatement Criteria from PDPM chapter 30 [40]	30
Table 2.6: Slatted CL-6 Post & Footing Dimensions from HDM 700 [2]	34
Table 3.1: Sample Service Request Report Data from District 3 IMMS, 2016	38
Table 3.2: IMMS LEMO data from District 12 the Fiscal Year 2017	42
Table 3.3: Field names and corresponding description for data in the LCS	50
Table 3.4: Enterprise Labor Expenditure Summary for Fiscal Year 2017	51
Table 4.1: Table of LEMO for Selected Roadside Features. Shown are the total number of Work Orders for 2017 along with the total LEMO, Labor and Maintenance costs, and the average cost per work order.	54

LIST OF ACRONYMS AND ABBREVIATIONS

Acronym	Definition
AHMCT	Advanced Highway Maintenance and Construction Technology Research Center
Caltrans	California Department of Transportation
COTS	Commercial Off-The-Shelf
DOT	Department of Transportation
DRISI	Caltrans Division of Research, Innovation and System Information
LEMO	Labor, Equipment, Materials, and Others
R&D	Research & Development
SR	State Route
TAG	Technical Advisory Group
CHP	California Highway Patrol
LCS	Lane Closure System
IMMS	Integrated Maintenance Management System
PII	Personal Identity Information
TASAS	Traffic Accident Surveillance and Analysis System

ACKNOWLEDGMENTS

It was not possible to perform this research without the help and input from many individuals from Caltrans districts who provided valuable data and information related to their experiences in the field. Their assistance and help is gratefully acknowledged. In addition, help and valuable input from Kenneth A. Murray, Jennifer Taira, Leona S. Burk, Hamid Ikram, Juan Araya, Joe Horton, and Justin Unck is also acknowledged.

CHAPTER 1: INTRODUCTION

Problem and Background

There is a need to develop new policies and practices for roadside features that support Caltrans' safety and asset management goals. The main objective here is to assist highway designs in including maintenance planning to improve worker safety and working conditions. Such policies and practices should be defensible and based on data and scientific methodologies and techniques.

Although research is available on the performance of standard roadway features such as barriers, light standards, and signs, etc.; there is lack of data and scientific methods that can be used in assessing maintainability of roadside features and the impact of the frequency of their maintenance on worker safety. Furthermore, there is no best practice or policy that can replace the expertise of the people who do the actual maintenance work at their home base. This is especially true in California where there are as many climate and environmental conditions as those that exist throughout the United States, and each roadway along each mile presents unique challenges and may cause exceptions to any design best practice. Therefore, there is a need for capturing the knowledge base of the local maintenance experts in understanding maintainability requirements for roadside features so that better methods or policies can be developed for their selection and design.

Objectives

This research study developed a list of specific roadside features that have a significant impact on worker safety due to exposure to traffic through time and location as well as those that use recurring maintenance resources. The goal was to help Caltrans develop revised policy documents that modernizes highway design and operational practices that provide for increased worker safety. This was done by providing supporting data and the necessary information. In addition, areas related to the maintenance of roadside features that would need additional research and those that would require additional training were identified.

Scope

The duration of the proposed research was 18 months distributed over three fiscal years starting with the 2016-17 fiscal year and ending in 2018-19 fiscal year and it represented the first phase of this research study. The scope was limited to evaluation of current practices within Caltrans districts and the existing Caltrans design manuals and guidelines. The results from this first phase was intended to provide the basis that can be used to identify the need for subsequent phases of this type of research study.

Overview of Research Results and Benefits

During this research, many discussions occurred with maintenance workers throughout all 12 Caltrans Districts. A number of roadside features were identified as being "high maintenance" as a function of time exposed to high-speed traffic by those who performed the actual work. In general, it is felt that "maintainability" is not considered in the design and cost assessment of

Performance Measures for Roadside Features

roadside features. If maintenance resources were included in the cost-benefit analysis in selection or design of roadside features, then, it was felt by most of the field workers, that different choices would have been made or different designs would have been selected for such roadside features.

The research questions answered by this research study include:

- What are the specific roadside features that cause lengthy amounts of time exposing workers to high-speed traffic or place workers in a high-risk environment when maintaining roadside features?
- What are the data sources and the resources spent on maintenance of roadside features and traffic collision data related to roadside features?
- What are the existing Caltrans policies, design guidance, manuals, plans, and specifications for selected roadside features?

The research results also included recommendations on areas where a revised policy or additional training can improve the use of maintenance resources as well as safety in maintenance functions associated with the critical roadside features. This research study also identified areas in which additional research or cost benefit analyses are needed that can provide a proper basis for decision making in selection and design of certain roadside features.

CHAPTER 2: LITERATURE REVIEW

This section is a compilation of available design guides that Caltrans regularly uses for the design of Roadside Features. Included are listings to various pages on Caltrans' website, along with comparisons to what the federal government and AASHTO recommend. Other state DOT design guides are also briefly discussed in each section. The following sections will focus on the specific roadside features that were mentioned multiple times when meeting with members of the Caltrans Maintenance departments of various districts.

Clear Recovery Zone (CRZ)

The Clear Recovery Zone (CRZ) defines a horizontal clearance to all roadside features (based on engineering judgment) with the intent of maximizing the distance between the roadway and roadside feature. Fixed objects can encroach into the CRZ as long as they are designed to reduce the severity of accidents. Fixed objects within the CRZ that cannot be made to be breakaway (like a pull box or large overhead sign) are usually protected by a guardrail barrier to reduce the severity of an accident. Although the CRZ is not a roadside feature, it is an integral part of what defines a roadside feature.

Caltrans CRZ requirements are defined in the Highway Design Manual (HDM) section 309.1, which also refer to the AASHTO Roadside Design Guide (AASHTO RDG) for more detailed information [1, 2]. HDM 300 defines a CRZ as "an unobstructed, relatively flat (4:1 or flatter) or gently sloping area beyond the edge of traveled way which affords the drivers of errant vehicles the opportunity to regain control." HDM 300 also explicitly lists two bare minimum requirements: Freeways and expressways must be 30 feet, while conventional highways must be 20 feet. Furthermore, HDM 300 lists that a minimum horizontal clearance to all objects must be at least 4 feet in section 309.1(3)(a). AASHTO RDG requirements go into more detail regarding speed, Average Daily Traffic (ADT), and slope gradients. The AASHTO RDG chart with recommended CRZ distances is shown below in Figure 2.1 [2].

Performance Measures for Roadside Features

Design Speed (mph)	Design ADT	Foreslopes			Backslopes		
		1V:6H or flatter	1V:5H to 1V:4H	1V:3H	1V:3H	1V:5H to 1V:4H	1V:6H or flatter
≤40	UNDER 750 ^c	7-10	7-10	b	7-10	7-10	7-10
	750-1500	10-12	12-14	b	12-14	12-14	12-14
	1500-6000	12-14	14-16	b	14-16	14-16	14-16
	OVER 6000	14-16	16-18	b	16-18	16-18	16-18
45-50	UNDER 750 ^c	10-12	12-14	b	8-10	8-10	10-12
	750-1500	14-16	16-20	b	10-12	12-14	14-16
	1500-6000	16-48	20-26	b	12-14	14-16	16-18
	OVER 6000	20-22	24-28	b	14-16	18-20	20-22
55	UNDER 750 ^c	12-14	14-18	b	8-10	10-12	10-12
	750-1500	16-18	20-24	b	10-12	14-16	16-18
	1500-6000	20-22	24-30	b	14-16	16-18	20-22
	OVER 6000	22-24	26-32 ^a	b	16-18	20-22	22-24
60	UNDER 750 ^c	16-18	20-24	b	10-12	12-14	14-16
	750-1500	20-24	26-32 ^a	b	12-14	16-18	20-22
	1500-6000	26-30	32-40 ^a	b	14-18	18-22	24-26
	OVER 6000	30-32 ^a	36-44 ^a	b	20-22	24-26	26-28
65-70 ^d	UNDER 750 ^c	18-20	20-26	b	10-12	14-16	14-16
	750-1500	24-26	28-36 ^a	b	12-16	18-20	20-22
	1500-6000	28-32 ^a	34-42 ^a	b	16-20	22-24	26-28
	OVER 6000	30-34 ^a	38-46 ^a	b	22-24	26-30	28-30

a) When a site-specific investigation indicates a high probability of continuing crashes or when such occurrences are indicated by crash history the designer may provide clear-zone distances greater than the clear zone shown in Table 3-1. Clear zones may be limited to 30 ft for practicality and to provide a consistent roadway template if previous experience with similar projects or designs indicates satisfactory performance.

b) Because recovery is less likely on the unshielded, traversable 1V:3H fill slopes, fixed objects should not be present in the vicinity of the toe of these slopes. Recovery of high-speed vehicles that encroach beyond the edge of the shoulder may be expected to occur beyond the toe slope. Determination of the width of the recovery area at the toe of slope should consider right-of-way availability, environmental concern, economic factors, safety needs, and crash histories. Also, the distance between the edge of the through traveled lane and the beginning of the 1V:3H slope should influence the recovery area provided at the toe of slope. While the application may be limited by several factors, the foreslope parameters that may enter into determining a maximum desirable recovery area are illustrated in Figure 3-2. A 10-ft recovery area at the toe of slope should be provided for all traversable, non-recoverable fill slopes.

c) For roadways with low volumes it may not be practical to apply even the minimum values found in Table 3-1. Refer to Chapter 12 for additional considerations for low-volume roadways and Chapter 10 for additional guidance for urban applications.

d) When design speeds are greater than the values provided, the designer may provide clear-zone distances greater than those shown in Table 3-1.

Figure 2.1: Clear Recovery Zone Recommendations from AASHTO Roadside Design Guide (units in feet) [1].

Various design speeds are shown in the first column with Design Average Daily Traffic (ADT) in the second column. The other columns refer to the slope vertical and horizontal distance. For example, 1V:6H means that for every 1 foot in height, there should be 6 feet in the horizontal distance. Figure 2.1 summarizes AASHTO CRZ recommendations, while HDM 300 contains multiple sections that are specific to various roadside features [1, 2].

Additional CRZ information can also be found in the HDM, e.g. Landscape planting CRZ information can be found in HDM 902.2 (2) [2]. Additional details regarding barriers and guardrail types specifically can be found in the Traffic Safety Systems Guidance document [3]. Furthermore, the California Manual on Uniform Traffic Control Devices (CA MUTCD) contains some limited requirements for various traffic control devices (signs, posts, etc.) and information on later offset can be found in section 2A.19 [4]. All guiding documents mention that fixed objects should be moved out of the CRZ if practicable; otherwise they should be breakaway or protected with a guardrail. Shoulders are defined in the HDM Table 302.1, which already lists 8 feet as a minimum for the right side of all highways and freeways (except for slow moving-vehicle lanes). Supplementary CRZ information can be found in Caltrans Standard Plans which are specific to

Performance Measures for Roadside Features

roadside features. An example of Roadside Signs is shown in Figure 2.2. Other standard plans for roadside features include similar drawings that depict the CRZ requirements [5].

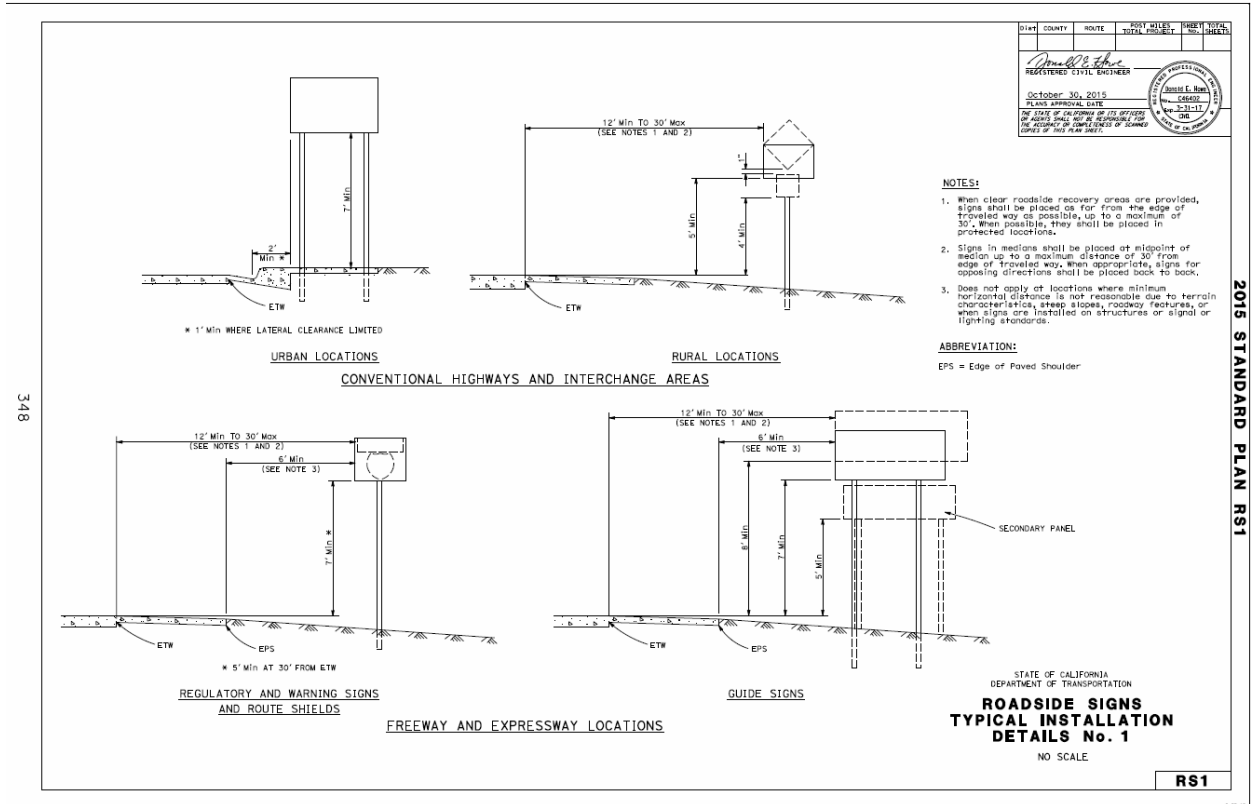

Figure 2.2: Standard Plan RS1 for Roadside Signs [5].

Many other state DOTs have discussed this same CRZ (horizontal alignment, etc.) concept and have similar, if not the same AASHTO policy. Delaware, Georgia, Massachusetts, Nebraska, New Jersey, and other state DOTs refer back to AASHTO RDG chapter 3 directly for CRZ standards [6-10]. Florida, Idaho, Illinois, Mississippi, Montana, New York, Pennsylvania, Washington, and other state DOTs prefer an adapted version of the AASHTO RDG CRZ standards [11-17]. For example, the New York HDM includes a horizontal curve adjustment factor (K_{oc}) as shown below in Table 2.1.

Table 2.1: Horizontal Curve Adjustment Factor for CRZ from New York HDM [15]

Radius of Curve (feet)	Design Speed (mph)					
	35	40	50	55	60	70
3000	1.1	1.1	1.1	1.2	1.2	1.2
2500	1.1	1.1	1.2	1.2	1.2	1.3
2000	1.1	1.2	1.2	1.2	1.3	1.4
1700	1.1	1.2	1.2	1.3	1.3	1.4
1500	1.2	1.2	1.3	1.3	1.4	1.5
1300	1.2	1.2	1.3	1.3	1.4	-
1150	1.2	1.2	1.3	1.4	1.5	
1000	1.2	1.3	1.4	1.5	1.5	
800	1.3	1.3	1.4	1.5	-	
650	1.3	1.4	1.5			
500	1.4	1.5	-			
300	1.5	-	-			

This factor is used for Curve Corrected Recovery Width (CCRW), which is based on the Basic Recovery Width (BRW) or the normal CRZ standards multiplied by the curve adjustment factor K_{oc} ($CCRW = K_{oc} * BRW$) [15]. This adjustment creates a larger recovery zone for errant vehicles during a high-speed turn. Other factors that states adjusted the CRZ width are right of way availability, environmental concerns, economic factors, safety needs, and accident histories. Similarly, a study was done regarding the effectiveness of CRZ which also recommend roadside design policies be flexible for each highway section [18].

Barriers and Guardrails

Barriers and guardrails are essential items used to shield pedestrians and roadside features from motorists’ vehicles. Barriers are designed to meet NCHRP Report 350 testing levels, which vary from Level 1 (low-speed standard passenger cars) to Level 6 (high-speed passenger cars and large tanker trailers) [19]. Newer MASH standards were completed in 2009, but there are very few approved barriers available for Caltrans use [20].

Barriers and guardrails are placed strategically to protect fixed objects inside the CRZ. Unlike the CRZ, which has a large section in the HDM, guardrails, and barriers are discussed in various places alongside the roadside features they are designed to protect. In the Caltrans HDM 309.1 (2)(a), guardrails are specified to be used “if a fixed object, when they are necessary highway features, cannot be eliminated, moved outside the clear recovery zone, or modified to be made yielding, it should be shielded by guardrail, barrier, or a crash cushion” [2]. Various guardrail types, installation criteria, and design considerations are further discussed in the Traffic Safety Systems Guidance (TSSG) section 3.3. These conditions include collision history, roadway alignment, operating conditions (volume, speed, merge, and weave areas), climate, and roadside recovery area. The TSSG provides a graph depicting the severity of need for guardrail placement depending on embankment height and the slope of the roadway, which is reproduced below in Figure 2.3 [3].

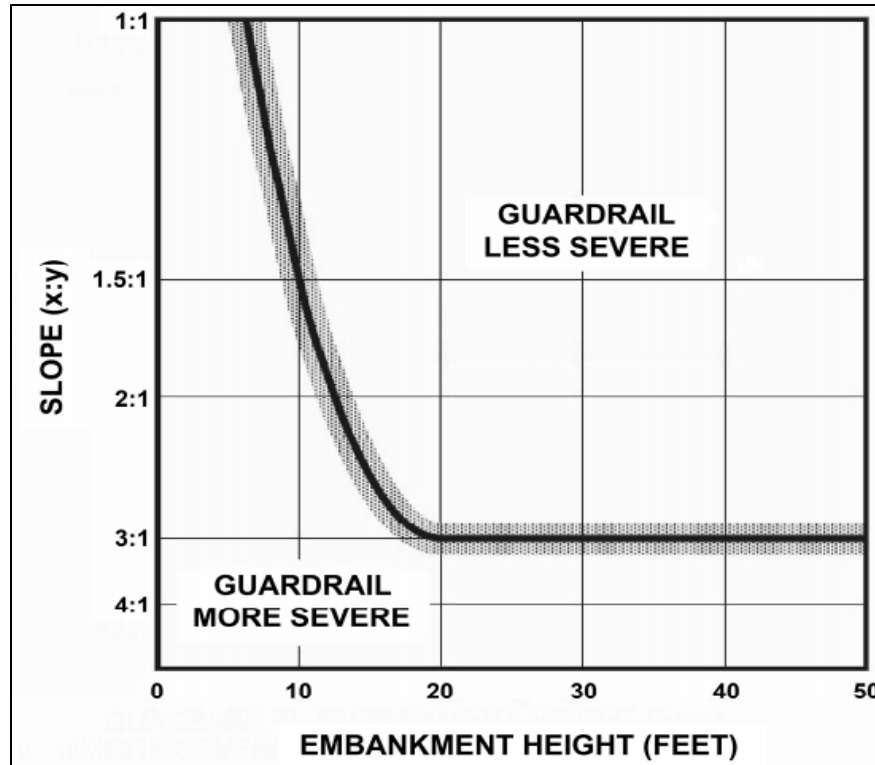

Figure 2.3: Equal Severity Curve for Guardrails from [3].

AASHTO has a similar design chart for embankment barrier considerations shown in Figure 2.4. The AASHTO RDG figure compares embankment height, slope, and ADT, whereas Figure 2.3 does not consider ADT. Figure 2.3 also helps the District Traffic Safety Engineer who “must concur with the decision to install or not to install guardrail and the type of end treatment at an embankment slope that meets the Guardrail Less Severe conditions” [3]. The HDM 800 contains general information for selecting appropriate types of end treatments (e.g. flared ends, projecting barrels, etc.) to protect inlet/outlet culverts. Length of Need (LON) requirements for guardrails and end treatments require a minimum of 150 feet and are further discussed for various conditions in chapter 3.6 of the TSSG [3]. Gating end treatments have the LON start at 12.5 feet to allow an impacting vehicle to pass through the system at a side angle impact within the first 12.5 feet, which are the exact same regulations found in chapter 8.3.2.3 of the AASHTO RDG [1].

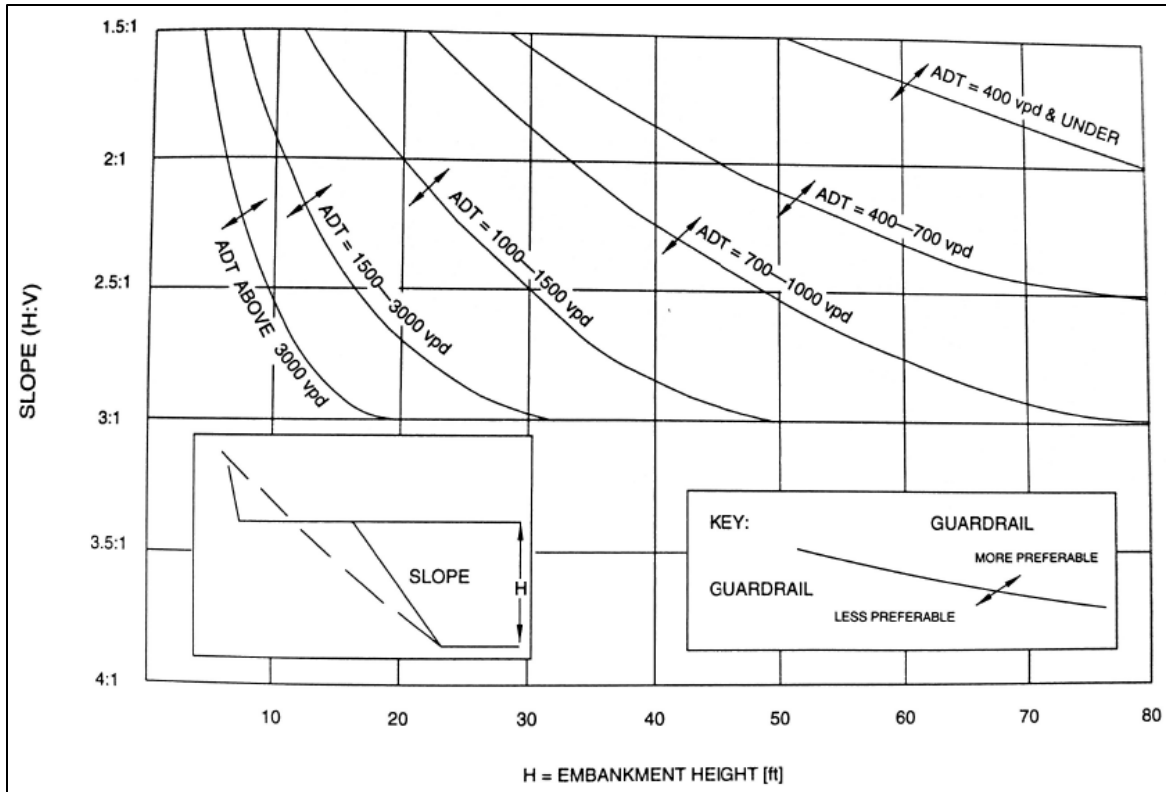

Figure 2.4: AASHTO Roadside Design Guide Design Chart for Embankment Barrier Consideration [7].

Other states provide very similar regulations and design guide criteria regarding barrier design. As mentioned previously, Caltrans only has a few MASH approved barriers available, but many other states have not even implemented MASH criteria completely by June 30, 2018, as seen from the FHWA website’s compiled list of all states and their status on implementing MASH criteria [21]. Placement design of other states are very similar to Caltrans as well. In the context of barrier placement, FDOT Plans Preparation Manual (PPM) consider lateral offset from the edge of traveled way, deflection space tolerance, terrain effects, length of need, space required for end treatments, and other outside shoulder or median application. Similarly, in FDOT PPM regarding barrier type selection, FDOT considers the traffic and site characteristics, the frequency of impacts, initial and replacement costs, maintenance ease and exposure, and aesthetics [22].

Standard plans for guardrails and barriers are provided from Caltrans on their website. A Type 60M RSP A76A Concrete Barrier is shown in Figure 2.5, but there are many other plans available (from A76A to A76L) that address various conditions from transitioning to other barrier types to a wildlife passageway version. A Midwest Guardrail system is shown in Figure 2.6, which also shows the standard spacing between the wooden posts [5]. Patina (or weathered steel) has a brief section in the TSSG which disallows usage in areas of high rainfall and salt content in the area. It also mentions that weathered steel must be examined annually and replaced as soon as possible with galvanized parts [3].

Performance Measures for Roadside Features

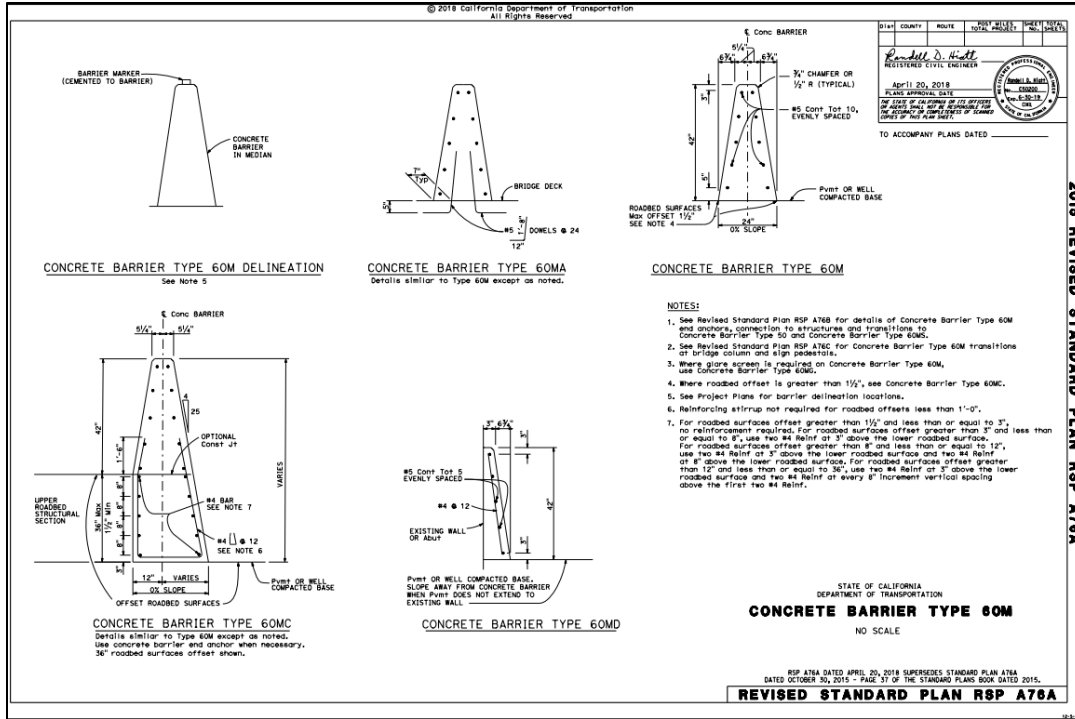

Figure 2.5: Standard Plan RSP A76A for Concrete Barrier Type 60M [5].

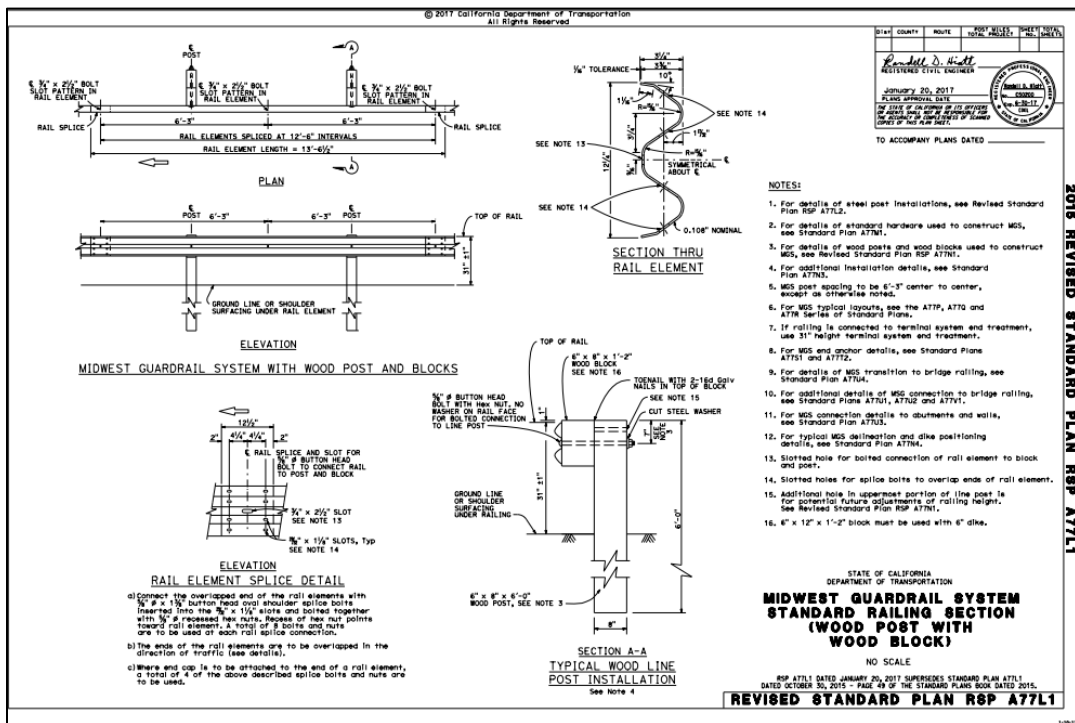

Figure 2.6: Standard Plan RSP A77L1 Midwest Guardrail System [5].

Performance Measures for Roadside Features

Most other states also use Standard Plans in a similar fashion to Caltrans. Because the MASH and NCHRP Report 350 are general standards, states will produce roadside feature standard plans that are equivalent to or greater than the crash test requirements of NCHRP Report 350 and MASH. Figure 2.7 shows a standard plan from FDOT for a concrete barrier. It provides all the design spacing and measurements along with a long list of general notes, which is like Caltrans' standard plan for concrete barriers seen in Figure 2.5.

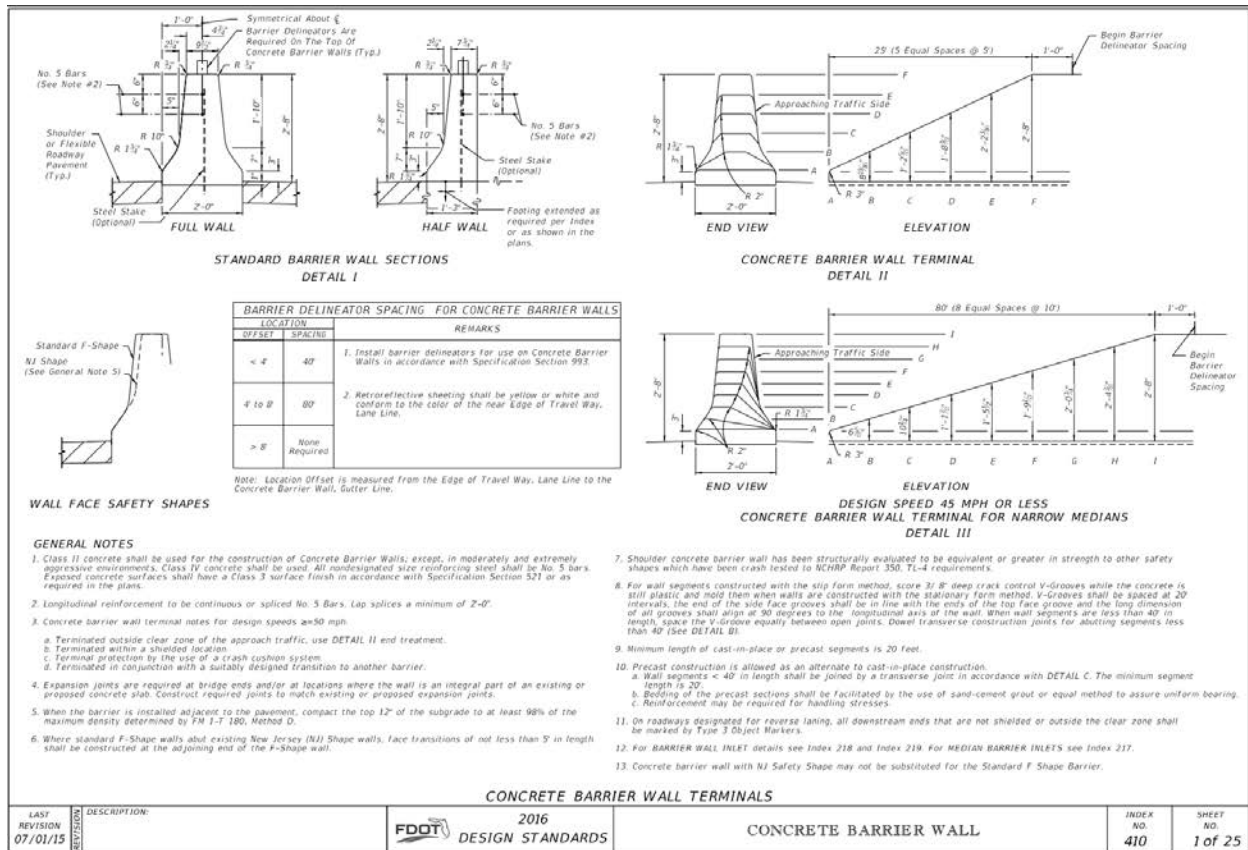

Figure 2.7: FDOT Standard Plan for Concrete Barrier Wall [23].

Landscaping and Irrigation

For landscape design, CRZ and sight distance are two major considerations that are mentioned in the HDM and the Landscape Architecture Planting and Irrigation Plans, Specifications, and Estimates (PS&E). Because the CRZ is designed to provide errant drivers room to regain control, large trees (which are usually part of the landscape) are considered fixed objects which are required to be offset from the edge of traveled way. HDM 900 states that on "freeways and expressways, including interchange areas, there should be 40 feet or more of clearance between the edge of traveled way and large trees: however, a minimum clearance of 30 feet must be provided." Additional considerations for roadsides and medians with curbs, barriers, and without curbs or barriers are summarized in Table 2. HDM 900 also defines a large tree as a tree that, within 10 years, has a trunk of 4 inches or greater in diameter measured 4 feet above the ground. Section

902.3 has more information and exceptions related to large tree plantings [2]. Landscaping PS&E has the same setback requirements for large trees listed in section 4 [24].

Table 2.2: Large Tree Setback Requirements on Conventional Highways [2]

ROADSIDE			
Condition	Posted Speed (mph)		
	≤ 35	40 – 45	> 45
With curb	<u>18" Min. from curb face</u>	30' Min from ETW	
With barrier	<u>Min. deflection distance from barrier face (barrier type specific)</u>	<u>Min. deflection distance from barrier face (barrier type specific)</u>	
Without curb or barrier	<u>30' Min from ETW</u>		
MEDIAN ^{(1), (2)}			
Condition	Posted Speed (mph)		
	≤ 35	40 – 45	> 45
With curb	5' Min. from curb face	Not Allowed	
With curb in Main Street context; where median width of 12' is not feasible and trees are a part of a community's transportation plan to improve livability that also includes transportation features for traffic calming through physical design such as modifying intersections or relocating traffic lanes to make space for bike lanes, sidewalks and landscaping. See the Department's "Main Street, California" document for more information.	18" Min. to 5' from curb face if approved by the District Director	Not Allowed	
With barrier	Concrete Barrier: 18" Min. from face of barrier Other Barrier: Min. deflection distance for barrier type, 18" Min.	Allowed if approved by the District Director	
Without curb or barrier	Not Allowed		

Notes:

- (1) Trees in the median shall be located at least 20 feet from manholes.
- (2) Trees in the median shall be located at least 100 feet from the longitudinal end of the median.

Sight distance setback is essential for landscaping because large plantings can obstruct the sight of drivers on the highway. Sight distance limit is defined by HDM 900 as being “measured from the edge of traveled way to the outside edge of the mature growth,” whereas plant setback “is measured from the edge of traveled way to the face of tree trunk or face of shrub foliage mass”[2]. Sight distance refers to the “continuous length of highway ahead, visible to the highway user,” and the HDM 201.1 provides a table for minimum standards which is reproduced below in Table 2.3. Further subsections of HDM 201 discuss sight distances for stopping at curves, various

grade crests, and stopping sight distance [2]. PS&E section 4 refers back to Topic 201 in the HDM for sight distance designs and mention that “particular attention should be paid to planting on the inside of curves, in interchange loops, in median areas, on the ends of ramps, and on cut slopes” [24]. There are two examples in the PS&E section 4 which illustrate an example landscaping design with regards to proper sight distance and planting setbacks with one reproduced in Figure 2.8.

Table 2.3: Sight Distance Standards from HDM 200 [2]

Design Speed ⁽¹⁾ (mph)	Stopping ⁽²⁾ (ft)	Passing (ft)
10	50	---
15	100	---
20	125	800
25	150	950
30	200	1,100
35	250	1,300
40	300	1,500
45	360	1,650
50	430	1,800
55	500	1,950
60	580	2,100
65	660	2,300
70	750	2,500
75	840	2,600
80	930	2,700

(1) See Topic 101 for selection of design speed.

(2) For sustained downgrades, refer to advisory standard in Index 201.3

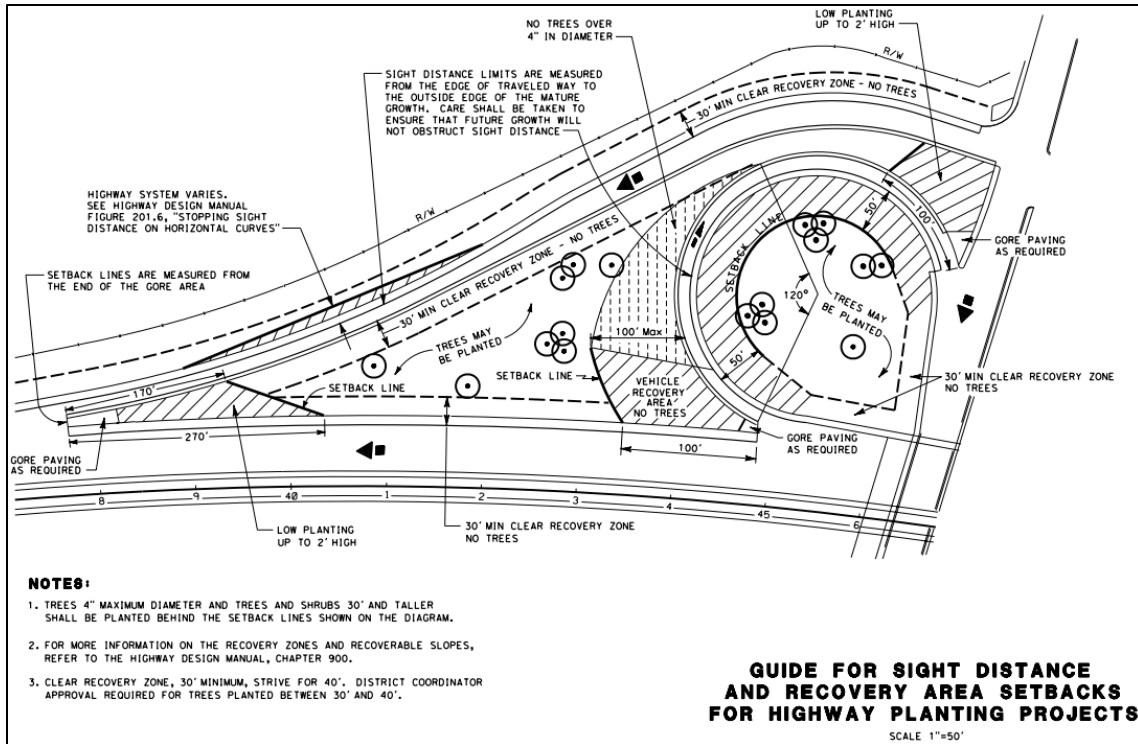

Figure 2.8: Caltrans PS&E Sight Distance Setback Example [25].

Other states use similar tree setback and sight distance requirements as Caltrans. Arizona Department of Transportation (ADOT) only places new trees after considering a Recovery Area, which is an adapted version of the CRZ requirements from Figure 2.1. ADOT also requires that trees on high-speed rural highways with trunks greater than 4 inches in diameter on or at the toe of fill slopes be identified for removal if within the recovery area, which is like the Caltrans' policy which disallows large tree plantings within the CRZ altogether. ADOT also provides Sight Distance requirements for tree placement and removal found in their Roadway Design Guidelines chapter 200 [26].

Irrigation regulations are provided in HDM 902.5 and recommend irrigation systems conserve water and minimize worker exposure. Valves, sprinklers, backflow preventers, placement, and access are discussed in the following subsections. PS&E section 5 and HDM 900 both contain considerations for maintenance access, the location of devices, pullouts, and maintainability. PS&E section 5 contains additional planting design questions that designers should ask themselves, including, but not limited to, safe access, maintenance exposure, planting selection to reduce pests and weed control, etc. For example, one question asks "does this design minimize maintenance worker's exposure to traffic?" Furthermore, there is a list that reviews good design practices and a mitigation plan checklist in PS&E Section 4-10 [24].

Planting guidelines, selection, and locations are discussed in HDM 902.4. More detailed guidelines are discussed in PS&E section 5, including quantity of plantings and what shrubs to put, how to calculate the correct area and spacing, fertilizers, mulch, and many other limitations. Further construction related information can be found in Caltrans Standard Specification Book. However, there is no real organization to the planting section 20-4.05 [27]. Many of the guidelines

Performance Measures for Roadside Features

consider using lower maintenance plantings that have longevity with a preference to use native plants. Vines for sound walls are only allowed if the vines naturally cling to the barrier as mentioned in the HDM 902.4 to reduce graffiti. Other state DOTs apply landscaping design in various ways that depend on the climate of their state. For example, Nevada (which is also in drought conditions) does not install irrigation at all unless an outside entity requests them. Only one section of Interstate 80 has irrigation maintained by NDOT, while the Federal Bureau of Reclamation created irrigation districts to provide and manage EPA water quality [28]. Texas DOT (which is another state in drought conditions) consider drip and/or bubbler irrigation systems that discharge water slowly while using automatic, electronic controllers with solar power (if permissible) for larger irrigation systems [29].

Hardscaping design (such as stamped asphalt, rock blankets, and patterned concrete) can be found on Caltrans Roadside Management Toolbox (CRMT). This tool is a webpage that provides various design techniques on various types of hardscaping treatments. The CRMT discusses what the treatments are as well as their benefits, limitations, specifications, and costs. For example, rock blankets should be used to compliment adjacent surroundings while using locally available cobble. Rock blankets should also be located away from pedestrian access, and special considerations should be considered when placing them in the CRZ [30]. Nevada also provides various hardscaping designs including rock blankets and rock walls as shown in Figure 2.9.

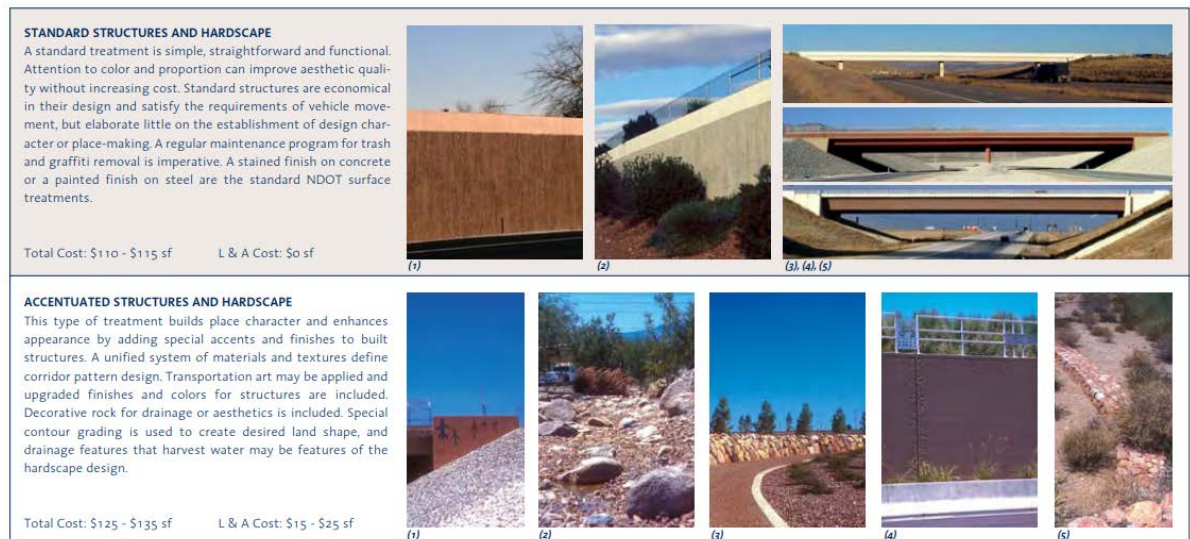

Figure 2.9: NDOT Structures and Hardscaping Treatments for I-15 Corridor [31].

Three critical issues surrounding landscaping throughout California are water conservation, fire prevention, and the promotion of native plants and biospheres. Resources can be found on all three of these subjects, but very few resources and research studies are in existence that address these subjects with respect to highway landscaping.

For landscaping in medians, hedgerow research may be well applied to California highways. Research into hedgerow design for farms to encourage pollinators, use native plants, and withstand windy and dry environmental conditions has been done for California farmers. Low maintenance landscaping in traffic medians and other selected areas along highways also have similar harsh conditions.

Storm Water and Trash Capture Devices

The primary purpose of a drainage system is to clear runoff water from the roadways while balancing environmental considerations. Proper drainage will simulate natural drainage in preventing flooding of highways with the added benefit of removing trash and gross solids from the storm water. Caltrans has well-defined objects in HDM 801.4 and continues to describe the basic drainage design policies in section 803 and beyond. All hydraulic and highway drainage facilities are designed to consider the peak discharge estimation. The many methods of estimating the peak discharge quantity (in cubic feet per second) are mentioned in HDM 818 and HDM 821.3. Other states use similar methods to design hydraulic roadside features; for example South Carolina DOT designs drainage based on 25, 50, 100, or 500 year flood volumes (100-year flood meaning a flood volume level that has 1 percent chance of being equaled or exceed in any given year) [32].

One example type of drainage device is the slotted drain, which is made using corrugated metal or polyethylene pipe and has a continuous slot on the top. Slotted drains are listed as suitable for all paved medians with super elevated sections to prevent sheet flow from crossing the centerline of a highway. Short sections of the slotted drain may be used as an alternative solution to a grate catch basin in the median or on the edge of a shoulder [2]. Pennsylvania DOT also uses slotted drains because they can intercept flow over a wide section, but they do not recommend them in high debris/sediment areas due to high clogging rates [16]. Drop inlets or other types of cleanouts should be provided at intervals of about 100 feet. Standard Plan D98-B, as shown in Figure 2.10 provided below, shows a more detailed design information [5]. They are also considered for usage in areas where local depressions would decrease safety and in locations of frequent intermittent low flows. Similarly, Pennsylvania DOT has many types of grated Inlets (Types C, D-H, M, and S) that are used as opening inlets [16].

Performance Measures for Roadside Features

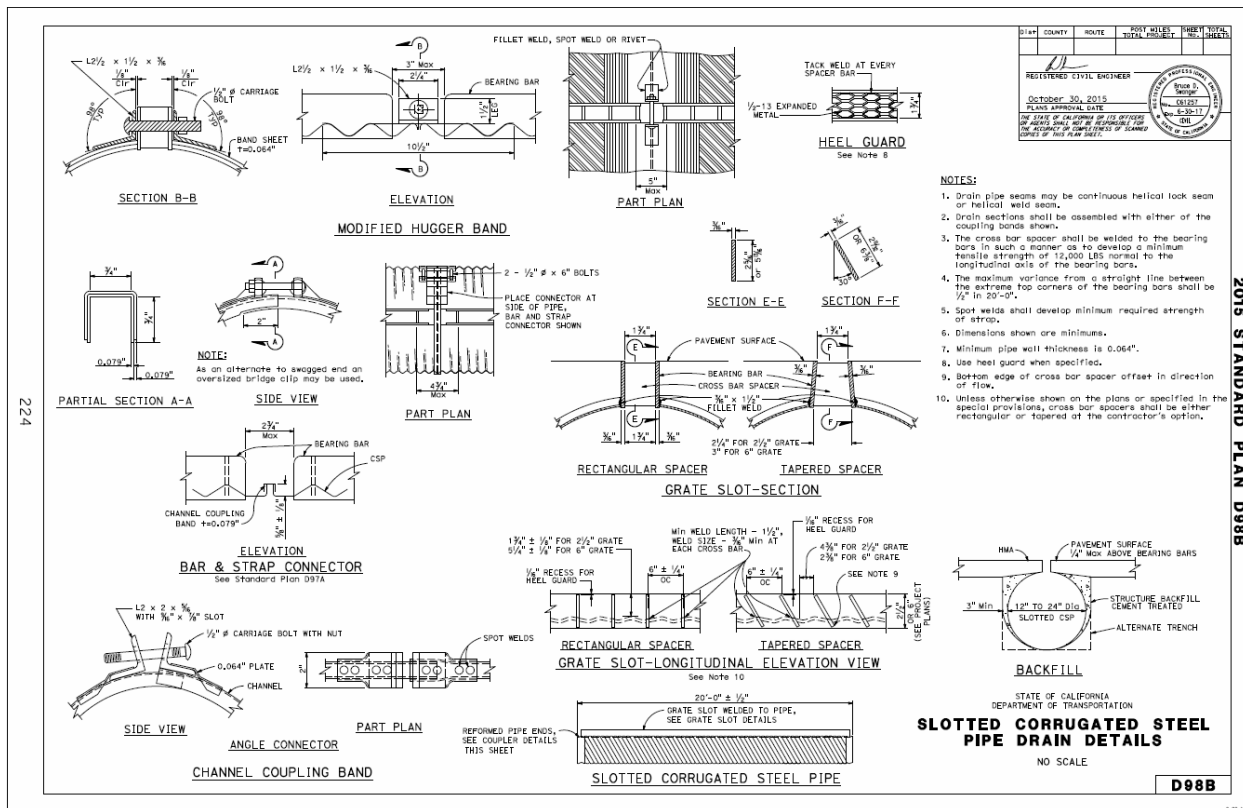

Figure 2.10: Standard Plan D98B for Slotted Corrugated Steel Pipe Drain [5].

A culvert consists of hydraulic and structural design because it must carry the flow across or from the highway as well as carry construction, highway traffic, and earth loads. Caltrans HDM 850 contains basic information on the physical characteristics of culvert shapes and materials, including, but not limited to, reinforced concrete pipes, concrete box, corrugated steel pipes, corrugated aluminum pipes, and plastic pipes (high-density polyethylene or polyvinyl chloride). Caltrans also refers to the FHWA Hydraulic Design of Highway Culverts and AASHTO Highway Drainage Guidelines for more detailed design information [33,34]. In contrast, South Carolina uses a computer program called HY-8 to perform design analysis on the culvert structure to improve performance while using the principles in the FHWA Hydraulic Design Series No. 5 [35].

Storm Water Best Management Practices (BMPs) help guide maintenance of storm water related activities. Each type of maintenance operation will have multiple BMPs that are applicable to the task and should be read before the activity is begun. Caltrans has an appendix full of storm water BMPs and have "Activity Cut-Sheets" that contain maintenance related BMPs for usage [36]. Appendix C of the Storm Water Quality Handbook contains all the various BMPs related to sediment control, erosion, drain protection, trash, litter, waste management, irrigation, etc. Each section describes the problem type, appropriate applications, implementation, and maintenance procedures. For example, the Litter and Debris section (section C.24.1) is intended to reduce the discharge of litter to storm water drainage. Applying this BMP is site-specific, and frequency will depend on the availability of resources and safety considerations. Implementation requires removal of litter and debris from drainage grates, trash racks, and ditch lines and securing or covering transported materials, equipment, and supplies to and from maintenance activity sites to prevent spillage on the roadway [36]. Georgia DOT has similar BMP procedures in their storm water

maintenance manual which describe the activity, function, inspection, and maintenance. Georgia DOT also provides a checklist form reproduced in Figure 2.11 for the inspector to document the assessment and any recommended actions for the future.

Manholes, Junction Boxes, Catch Basins, and Inlets Inspection Checklist Form A-3	
Structure ID #:	Inspection Date:
Inspector:	Installation Date:
Inspection Type: <input type="checkbox"/> Initial <input type="checkbox"/> Routine/Scheduled <input type="checkbox"/> Follow-up <input type="checkbox"/> Complaint <input type="checkbox"/> Other:	
Inspection Notes: 	
Structure Type and Description:	
<input type="checkbox"/> Inlet <input type="checkbox"/> Standard Drop <input type="checkbox"/> Standard Precast Drop <input type="checkbox"/> Standard Drop Types V-1 and V-2 <input type="checkbox"/> Drain Inlet <input type="checkbox"/> Standard Drop Types M-1 and M-2 <input type="checkbox"/> Standard Median Drop <input type="checkbox"/> Special Design Median Drop <input type="checkbox"/> Type "V" <input type="checkbox"/> Modified Standard 5001-M Drop <input type="checkbox"/> Ditch Drop <input type="checkbox"/> Safety Inlet with Grate	
<input type="checkbox"/> Headwall <input type="checkbox"/> Standard Pipe Culvert Concrete <input type="checkbox"/> Standard Tapered Inlet or Outlet <input type="checkbox"/> Standard Rubble Masonry for Pipe Culvert	
<input type="checkbox"/> End wall <input type="checkbox"/> Standard Pipe Arch Culverts <input type="checkbox"/> Standard Sand Cement Bag Rip Rap	
<input type="checkbox"/> Junction Box; Pipe Collars, Pipe Elbow and Pipe Curve Alignment	
<input type="checkbox"/> Intersection	
<input type="checkbox"/> Stand Pipe	
<input type="checkbox"/> Manhole <input type="checkbox"/> Standard Brick <input type="checkbox"/> Standard Precast Reinforced Concrete	

Figure 2.11: Georgia DOT Inspection Checklist for Manholes, Junction Boxes, Catch Basins, and Inlets [37].

Sound Walls

The purpose of a sound wall (or noise barrier) is to limit highway noise into adjacent areas. Noise abatement criteria can be found in the Project Development Procedures Manual (PDPM) chapter 30 and is reprinted in Table 5 below for convenience. These noise abatement criteria are adapted from the FHWA Noise Abatement Criteria (NAC) with which some DOTs (Texas, Illinois, etc.) use directly as the standard [13,38,39]. Noise barriers are normally constructed on state highway right-of-way. However it may be more appropriate to construct them on private properties depending on the topography. To construct noise barriers on private property, the

landowner must enter into a contract with Caltrans to allow construction on their property and allow periodic inspection. More details are described in PDPM Chapter 30 Section 1 [40].

Table 2.4: Noise Abatement Criteria from PDPM chapter 30 [40]

Activity Category	Hourly A-Weighted Sound Level dBA, Leq(h)	Description of Activity Categories
A	57 exterior	Lands where serenity and quiet are of extraordinary significance and serve an important public need, and where the preservation of those qualities is essential if the area is to continue to serve its intended purpose.
B	67 exterior	Picnic areas, recreation areas, playgrounds, active sports areas, parks, residences, motels, hotels, schools, churches, libraries, and hospitals.
C	72 exterior	Developed lands, properties, or activities not included in Categories A or B above.
D	--	Undeveloped lands.
E	52 (interior)	Residences, motels, hotels, public meeting rooms, schools, churches, libraries, hospitals, and auditoriums.

Noise barrier design criteria are discussed in topic 1102 of the HDM and include restrictions for location, height, length, and more. Because a noise barrier is a fixed object, it has the same CRZ requirements for lateral clearance as discussed previously. HDM 1102.2 also requires that “when lateral clearance is 15 feet or less, the noise barrier shall be placed on a safety shape concrete barrier.” Similarly, sight distance requirements still apply, and gore areas should begin or end at least 200 feet from the theoretical curb nose location. The height of a noise barrier is limited to 6 feet to a maximum of 14 feet [2]. Caltrans provides sound wall standard plans on the web with one reprinted below in Figure 2.12.

Performance Measures for Roadside Features

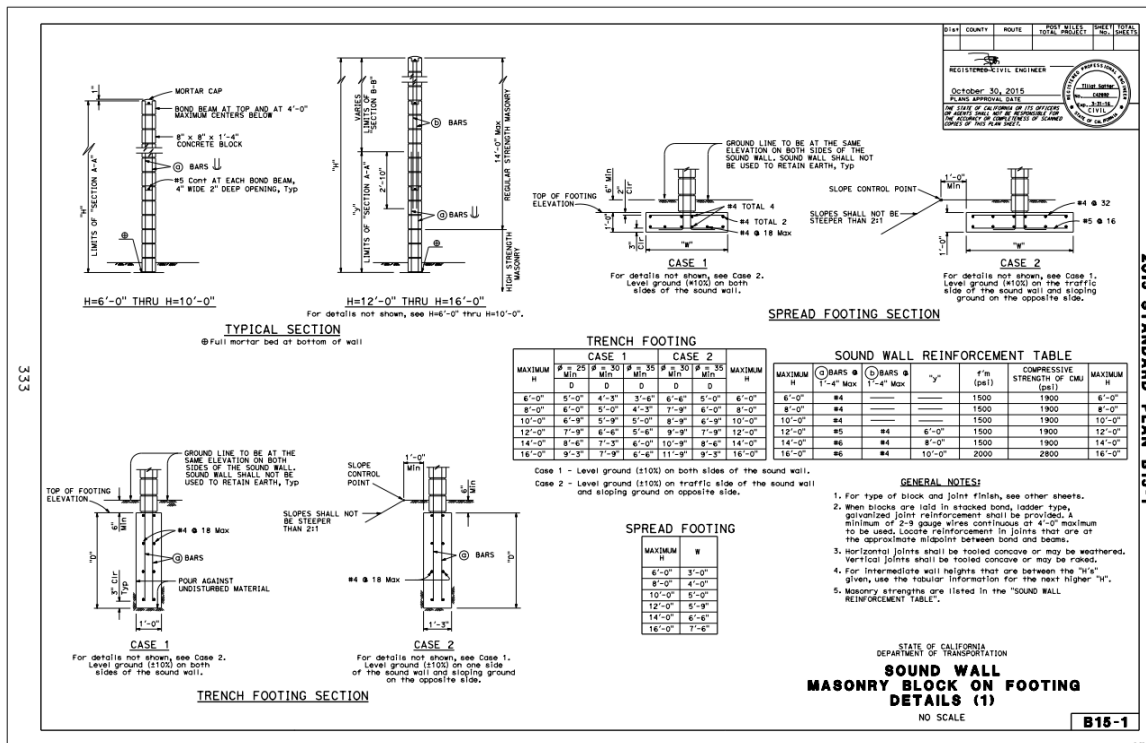

Figure 2.12: Standard Plan B15-1 for Sound Wall Masonry Block on Footing Detail [5].

Although the noise barriers are placed to strategically reduce noise for the nearby public, plantings and landscaping nearby are placed for aesthetics and graffiti control. PDPM recommends involving the local community to participate in protecting the community’s image and the plants from vandalism. The HDM also recommends some aesthetic treatments from the DES Office of Structure Design or consulting the District Landscape Architect for non-standard treatments.

Signs

Signs are a type of Traffic Control Device (TCD) that is designed to provide regulation, warning, and guidance for all roadway users using words, symbols, and arrows. Caltrans has compiled a document full of standards, and regulations for TCDs titled the California Manual on Uniform Traffic Control Devices (CA MUTCD), which is based off the FHWA MUTCD with supplemental provisions. Only 9 states (including California) have adopted a state version of the MUTCD whereas the other 41 states either directly adopted the FHWA MUTCD or adopted the FHWA MUTCD with some supplementary documents. A full list of these states can be found on the FHWA website [41]. Caltrans has a couple added sign designs in the CA MUTCD, whereas Montana does not have an MUTCD at all and relies on the Road Design Manual for sign placement. In general, all sign placement is governed by the CRZ (or lateral offset) which can have varying distances within each state [14].

Sign dimensions and sizing are regulated by many tables in the CA MUTCD, and drawings from FHWA’s “Standard Highway Signs and Markings”, and Caltrans’ California Sign Specifications [4,42,43]. The FHWA’s “Standard Highway Signs and Markings” is found online and contains PDF or EPS files of regulatory signs with measurements, color design, arrows,

symbols, etc. Similarly, the Caltrans' California Signs Specifications found online contain PDF files of sign specifications with an example shown below in Figure 2.13.

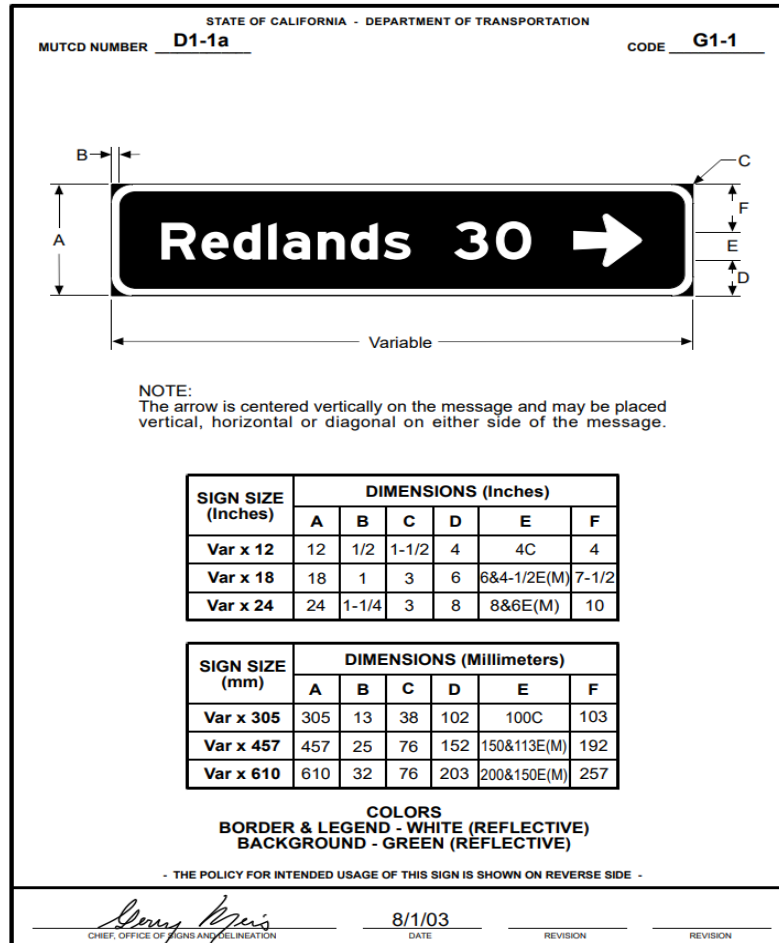

Figure 2.13: Destination Sign Specification G1-1 [43].

The structural support of signs is an important component in keeping a sign upright in varying wind conditions while still being breakaway or yielding in case of an accident. The CA MUTCD refers to the AASHTO book titled “Standard Specifications for Structural Supports for Highway Signs, Luminaires, and Traffic Signals” [44]. Section 3 of AASHTO’s book discusses all the various types of static and dynamic loading on signs and the base support. Included are equations for designing to specific wind speeds and wind pressures with many tables to calculate drag coefficient values for sign panels and supports. The FHWA has a similar book titled “Guidelines for the Installation, Inspection, Maintenance, and Repair of Structural Support for Highway Signs, Luminaires, and Traffic Signals” [42]. In terms of materials, there are wood, aluminum, and steel. Steel is typically the strongest but heaviest, while aluminum is lightweight and corrosion resistant but has only about 40% the yield strength of steel. The FHWA recommends round tubes for bending resistance on all axes, higher torsional resistance, and lower drag coefficient and associated wind loading. South Dakota and Iowa (which are two of the windiest states in the USA) DOTs both design towards the Federal requirement of 90 mph wind loading but have separate requirements for types of metal and wood posts [45, 46].

Performance Measures for Roadside Features

Sign placement is once again guided by the CRZ and “should be placed on the right-hand side of the roadway where they are easily recognized and understood by road users” [4]. It is possible that a sign not be placed on the right-hand side, but they should only be supplementary to normal locations, except in cases stated by the CA MUTCD Section 2A.16-05. If a sign must be placed in the CRZ, the CA MUTCD recommends the sign be placed on a breakaway or yielding support in section 2A.19. Signs should also be placed to optimize visibility and not obscure each other, nor should a sign obscure sight distance to an approaching vehicle on a major street from drivers stopped on a minor street. Additionally, there must be a minimum spacing of 200 feet between guide signs on conventional highways and 800 feet on freeways/expressways [4]. An example Caltrans sign standard plan is shown below in Figure 2.14.

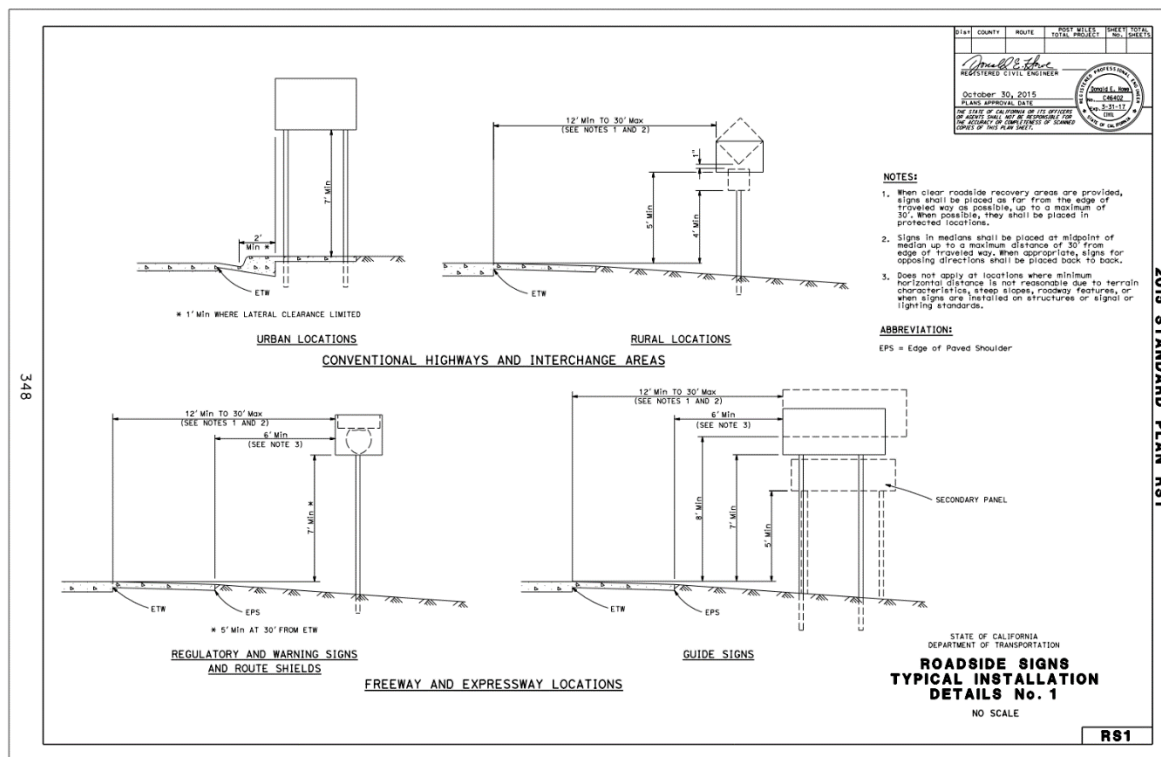

Figure 2.14: Standard Plan RS1 Roadside Sign Typical Installation [5].

Fencing and Access Issues

The purpose of fencing serves as access control to establish restricted areas using a physical barrier. Standard fencing includes Chain Link Type CL-6 fence for access control along right of way in urban or developed areas, Median Type CL-4 fence with the distance from the ground to the bottom tension wire increased to 6 inches, and Barbed Wire (Type BW) or Wire Mesh (Type WM) on wood or metal posts depending on the surrounding terrain. The HDM provides recommended post size and embedment measurements for CL-6 fencing as reproduced below in Table 6. There are special cases where walls or other types of nonstandard fencing may be used which are discussed in section 701.2-3 of the HDM. Fencing placement on freeways should be placed adjacent to the right of way line. Users should also remember that fencing will obstruct

Performance Measures for Roadside Features

sight distance (which was previously discussed with CRZ) and to avoid right angle jogs for maintenance.

Table 2.6: Slatted CL-6 Post & Footing Dimensions from HDM 700 [2]

Condition	Post NPS (Standard Cut)	Footing	
		Diameter	Depth
Unconstrained	4"	18"	3'-6"
Constrained	4"	18"	5'-6"

A chain link fence standard plan is reprinted below in Figure 2.15. Typical fencing dimensions are shown on the fencing drawing with a table listing maximum dimensions for each member. Positions for braces, tension wires, truss rods, etc. are also shown. Other states have similar procedures and standard plans and usually, only differ in terms of dimension and material/mesh used. For example, Florida has a standard plan Type B Fencing (Chain Link) shown in Figure 2.16 which can be compared with Caltrans Standard plan A85 Chain Link Fencing in Figure 2.15.

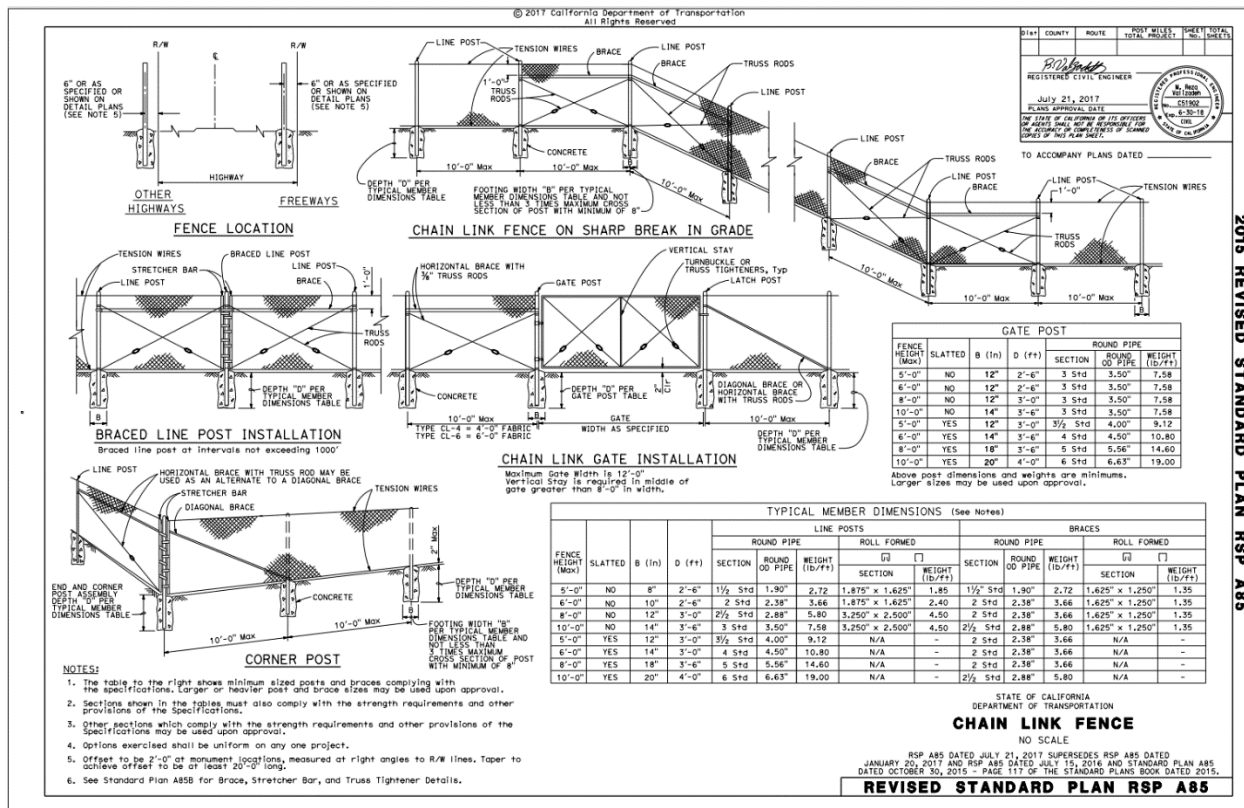

Figure 2.15: Standard Plan RSP A85 for Chain Link Fence [5].

Performance Measures for Roadside Features

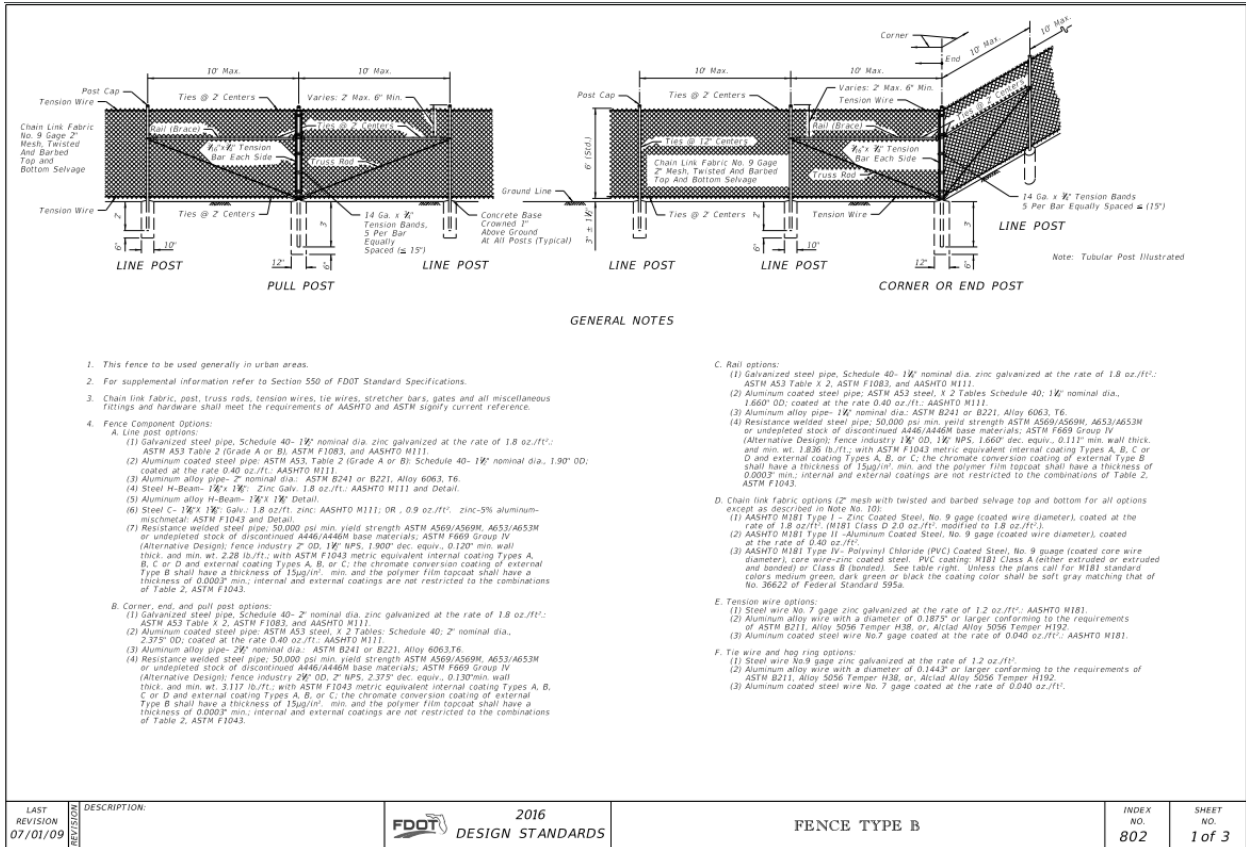

Figure 2.16: Florida DOT Standard Plan for Type B Fence [23].

Electrical

Pull boxes and wiring are important pieces to connect electrical equipment, including traffic signals and highway lighting. It is crucial to keep wiring short enough to limit the voltage drop to less than 5%. This can simply be calculated using the equation found on the traffic manual as Volts Drop = 2 * I * L * R, where I is the current, L is the wiring length, and R is the resistance of the wiring (depending on the type of wire). Normal traffic signals and flashing beacons require 120V AC, highway lighting may use 120V or 240V AC, and extensive lighting may require 480V AC. Pull boxes are useful to limit the length of wiring and provide access points to splice the wiring for other roadside features with electrical needs. Pull Boxes should be installed every 60 meters or less and adjacent to the foundation of a signal standard, lighting standard, illuminated sign, controller/service cabinet, and/or at the toe of slope or hinge point. Because pull boxes are considered fixed objects, they fall under the rules of the CRZ and should be installed further from the traveled way [47]. Included in Figure 2.17 is the standard plan for a structure pull box which has detailed dimensions for the pull box and the cover.

Performance Measures for Roadside Features

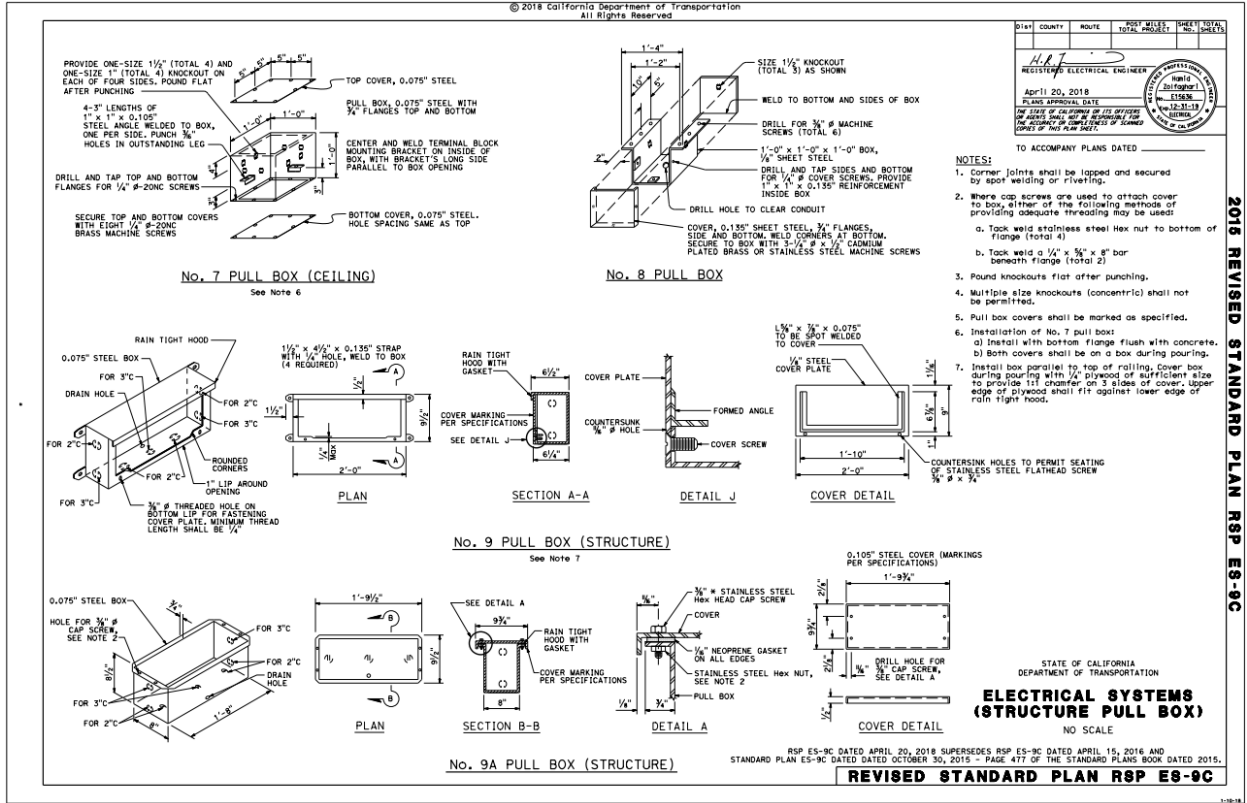

Figure 2.17: Standard Plan RSP ES-9C for Structure Pull Box [5].

CHAPTER 3:
CALTRANS DATABASE RESOURCES

This section contains information on available resources that contain data relevant to the maintenance operations of California roadside features. This data is obtained from databases implemented within Caltrans and can provide objective measures of the resources allotted in roadside feature maintenance operations.

IMMS

The IMMS database allows the Division of Maintenance access to input all electronic data related to maintenance needs. For this research, Service Requests (SQ), Work Orders (WO), and Labor, Equipment, Materials, and Others (LEMO) data for the fiscal years of 2012-2017 were extracted into Excel files for further analysis.

Service Requests and Work Orders

Service Requests are created when there is a need for maintenance on the roadways. An example of this would be a civilian finding a pothole in his/her area that needs to be filled and will go file a SR so that Maintenance can fix the pothole. Once the SR is filed, a WO will be created and the repair will be scheduled. A sample dataset of the SR from the IMMS database is shown below in Table 7. Problem codes are acronyms that define what highway feature needs maintenance, for example, ACCDT stands for Accident. Although Problem codes from SRs determine what type of maintenance problem needs to be resolved, they are not specific enough to define types of Roadside Features.

Table 3.1: Sample Service Request Report Data from District 3 IMMS, 2016

Dist	SR #	Source	Prob	Prob Date	Comments	Location	WO#
03	963437	CHP	ACCDT	02-Feb-2016	4224 FT NORTH OF WILSON AVE. CHP REPORT #9285-2016-0114.	S/B, SUTTER CO., SR-99, POSTMILE 99-SUT-17.60. REPAIR/REPLACE FENCE.	3855712
03	966858	CHP	ACCDT	05-May-2016		WB 50 JEO 15TH CAR FIRE WITH POSSIBLE INFRASTRUCTURE DAMAGE TCAL#3-57314 SA01517	
03	967336	CHP	ACCDT	07-May-2016		03-PLA-080 80WB JEO CISCO, BIG RIG IN THE CD / PC ENVIRO FOR LESS THAN 10GAL OIL IN DRAIN / CT RESP 2 CREW FR KV 5/07/16 - PC ENVIRO 1097-5/8@0800, 1098@0850 (JUSTIN-ENVIRO 613.5662)	3934076

Performance Measures for Roadside Features

Work Orders are created when maintenance crews complete a service request. Work Orders have their own set of codes called Activity Codes, which define what type of maintenance activity was performed at the worksite. Some of the activity codes can be easily extracted (guardrails and end treatments already mentioned), but some activity codes are not specific enough to sort out roadside features. For example, M40010 is used to describe sign repair and replacement, but unless the Work Order contains a note describing the exact sign or inventory number, it will be difficult to extract specific information on the type of sign being maintained. No cost related data is included with Work Order extraction, but there is information on Post Mile Markers to locate the exact highway location maintenance work was completed. The total amount of work orders in a fiscal year provides information on the maintenance demand each roadside feature requires and is shown in Figure 3.1 for the fiscal year of 2017.

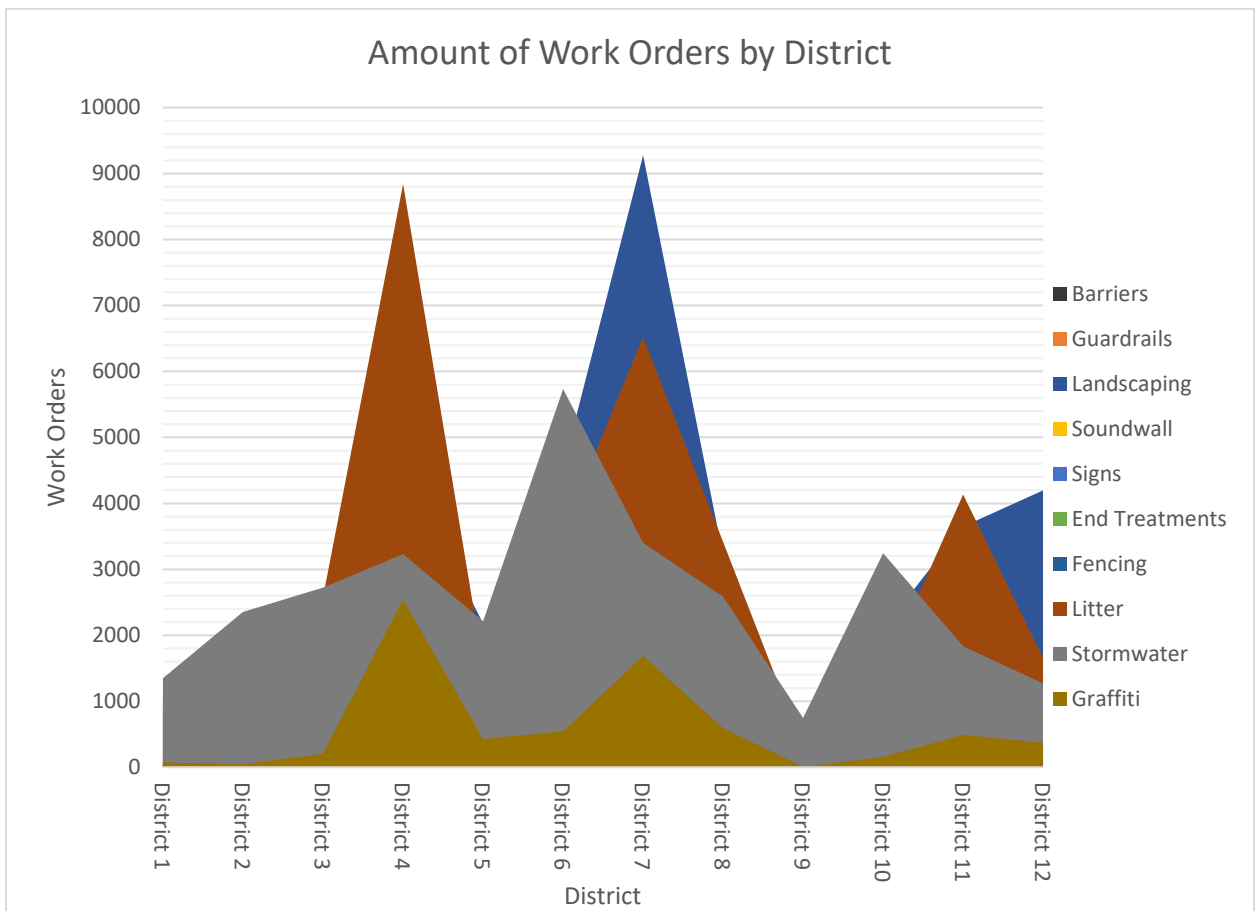

Figure 3.1: Work Orders Completed for Each District for Fiscal Year of 2017.

As seen in Figure 3.1, landscaping is one of the largest peaks, indicating that a significant amount of maintenance work is completed for landscaping related roadside features. The total work orders for Landscaping are 38,546 followed by Litter at 35,705 and storm water at 30,683 for the fiscal year of 2017. These values are the sum of all work orders from all districts combined in 2017. This data allows us to compare which roadside feature requires the most amount of maintenance. A detailed discussion on “Activity Codes” can be found in the next section.

Activity Codes

IMMS uses various coding systems to organize data with Activity Codes being one of the most common ones. The type of work is defined in Chapters while Chapters are further sorted by lettered Family Codes. For example, a Family represents Vegetation Control while the Activity Codes represent Landscaping Activities. Following the Activity Codes are 5 numbers to sort out various activities, for example, M60010 stands for Guardrail repair and replacement of rail only, compared with M61010 which is for repair and replacement of end treatments only. For this project, these ACTs are sorted out into Roadside Features instead of the typical family codes. This may not be completely accurate and requires further tuning, but it is able to sort out IMMS data to compare the costs need to maintain Roadside Features. The following subsections will describe how ACTS were sorted into Roadside Features and what relevant information can be obtained from the sorted IMMS data.

Barriers

The codes sorted into barriers include J60010, J60040, J60060, M70010, and M80010. The three J Family Codes here represent repair, replacement, and maintenance of channelizers. The two M Family Codes here represent repair and replacement of Barriers and Attenuators. These codes only allow us to understand the maintenance of barriers and attenuators in general. It is unable to describe what type of barrier it is, nor does it describe what type of part is being replaced/repared. The cost of the type of barrier maintenance or barrier part cannot be partitioned reliably.

End Treatments

There is one Activity Code related to end treatments which is M61010. This code represents repair and replacement of guardrail end treatments. This includes determining the nature or work, removal/installation of rail posts, raising end treatments to conform to pavement grade, and/or checking/tightening bolts/hardware. The issue with this single code is that many of the end treatment issues that maintenance brought up are related to specific end treatments. This single end treatment code does not allow for the many (20-30) types of end treatments to be separated and compared to cost.

Fencing

There is only one Activity Code related to fencing which is C40010. This activity is used when repairing or replacing right of way fencing, gates, or any other Caltrans owned fence. It would be preferred to be able to separate the many types of fencing (simple chain link, diamond studded fencing, etc.) and the reason the fencing was damaged (homeless cutting through the fencing, general stealing of fencing, etc.).

Guardrails

There is only one Activity Code related to guardrails which is M60010. This task includes repair and replacement of any type of guardrail including metal beams, concrete, etc. Because

Performance Measures for Roadside Features

many districts would like to see more concrete guardrails, it would be beneficial to be able to separate the types of guardrails that are listed under this single code.

Graffiti

There are two Activity Codes related to graffiti which are D60050 and D90000. These codes describe graffiti removal from all assets and illegal sign removal. Cleaning of graffiti includes cleaning or painting signs, sound walls, and other roadside features. Graffiti is universal and can be applied to just about every roadside feature.

Landscaping

There are multiple Activity Codes related to landscaping which are: C20040, C21040, C22040, C23040, C24040, C30020, C30040, C31040, C32040, E10040, E11040, E12040, E13040, E14040, E21040, E22040, E23040, E24040, E25040, E30010, E31010, E32020, E33040, and E34040. In general, these codes refer to the mechanical, chemical, and manual control of all vegetation and landscaping, tree inspection, trimming, and removal. Also included in these codes are irrigation related activities including irrigation system and electrical repair. With respect to weed control, with the mechanical, chemical, and manual control Activity Codes, they can easily be separated for further analysis. However, further research may be needed if it is needed to partition the various irrigation and sprinkler systems that maintenance works on.

Litter, Debris, Trash Capture

There are multiple Activity Codes related to litter, debris, and trash capturing systems which are: D30050, D40050, D40150, D41000, D41001, D41050, D42050. D30050 refers to roadway sweeping whereas D40050 and D40150 are both done by hand to remove debris from the right of way and the traveled way respectively. The 41000 codes are once again removing debris but related to Adopt-A-Highway, while D42050 is specific to illegal encampment debris removal. These are all very specific tasks, and the final code D42050 is specific to illegal encampments, which can be related to the homeless issues of each district.

Signs

There are five Activity Codes related to Signs which are M40000, M40010, M40120, M41000, and M41010. The M40000 activity refers to sign fabrication, including, but not limited to, the design and layout of the sign, cleaning substrate, applying sheeting to the substrate, and application of graffiti protection. M40010 refers to work including setting up temporary signs, removing and installing sign supports, repair/replacement, and cleaning of signs (not including graffiti). M40120 relates to performing a formal night inspection of signs, whereas M41010 is specifically for work on overhead sign structures to restore the sign to full service. The final activity M41000 is for installing/removing graffiti deterrent, which could be listed under Graffiti instead of Signs. For the future, there needs to be a way to differentiate between different types of signs and signposts that are being impacted to complete an in-depth study of various types of signposts.

Performance Measures for Roadside Features

Sound wall

There is one Activity Code related to sounds walls which is C90010. This Activity Code refers to repair and replacement of any type of right of way walls including components (cable fencing). The problem with this single code is that it refers to all types of walls whereas this study only wants to obtain sound wall information.

Storm Water

There are many Storm Water related Activity Codes which are C50010, C50150, C51010, C51050, C60010, C60050, C60220, C94010, C94040, C94050, F10003, F10006, F10007, F10009, F10030, F20005, F20020, F20030, F20050, F30005, F30020, F30120, F30201, F30220, F30301, F40030, F40050, F40060, F40120, F40310, F70003, F70020, F70030, F70050, F70101, F70103, F70110, F70201, F80001, F80002, F80003, F80004, F80005, F80006, and F80007. C50010 and C50150 are both related to ditches and channels with the first being repair and replacement and the latter cleaning to restore hydraulic capacity. Similarly, to the first two Activity Codes, C51010 and C51050, are both related to curbs and dikes with the first being repair and replacement and the latter cleaning to restore hydraulic capacity. C60010 and C60050 once again are repair and replacement and cleaning, but for drainage in general which would apply to everything outside of the first four codes. The final three C Family Codes C94010, C94040, and C94050 are related to repair and replacement, testing, and cleaning of drywells. These C Family codes are specific enough to separate them by each type of storm water device. However, the most talked about problematic storm water device (slotted drains) does not have its own activity code.

The F Family Codes are related to storm water management programs. For example, F2005, F20020, F20030, and F20050 are related to drain stenciling and inlet inspection. The F30000 codes are related to storm water facilities and activities inspections such as water treatment plants. F70000 codes are related to structural treatment and low impact development Best Management Practices (BMPs). In general, not many of the storm water Family Codes will be useful for our purposes.

Labor, Equipment, Material, Other (LEMO)

LEMO data reports back all labor, equipment, material, and other cost related maintenance data from IMMS. Because the LEMO data uses the same Activity Codes as Work Orders, the data can be sorted out by Roadside Feature, and a preliminary cost analysis was completed. Although Caltrans sorts out their data into Families, this structure doesn't directly fit into specific Roadside Features as discussed previously. However, the LEMO can be used to estimate the maintenance costs for each type of roadside feature. A sample of LEMO data extracted from the IMMS website is shown below in Table 3.2.

Table 3.2: IMMS LEMO data from District 12 the Fiscal Year 2017

Dist	WO No.	Activity	Hours	Labor	Vehicle	Material	Other	Total
12	4328598	A10110	41	1669.757	210.48	0	0	1880.237
12	4078735	A10110	54	2183.381	206.28	168.4	450	3008.061

Performance Measures for Roadside Features

12	4051104	A10110	59.5	2411.89	341.68	294.7	450	3498.27
12	4087084	A10110	45	1661.659	112.14	252.6	450	2476.399
12	4098980	A10110	90	3040.362	417.74	715.1	450	4623.202
12	4286398	A10110	40	1498.101	243.68	513	900	3154.781
12	4320052	A10110	98	3405.807	384.39	1253	450	5493.197

All the LEMO cost data is currently organized into activity codes while combining all 12 districts of Caltrans. The figures below show the various LEMO costs associated with Roadside Feature Activity Codes for the fiscal year of 2017, with Labor usually being the highest cost. Barriers, signs, litter, storm water, and landscaping have a significant number of associated Activity Codes and are all plotted separately in Figure 3.2-3.7, while guardrails, sound walls, end treatments, fencing, and graffiti have only one or two Activity Codes and are plotted together in Figure 3.7.

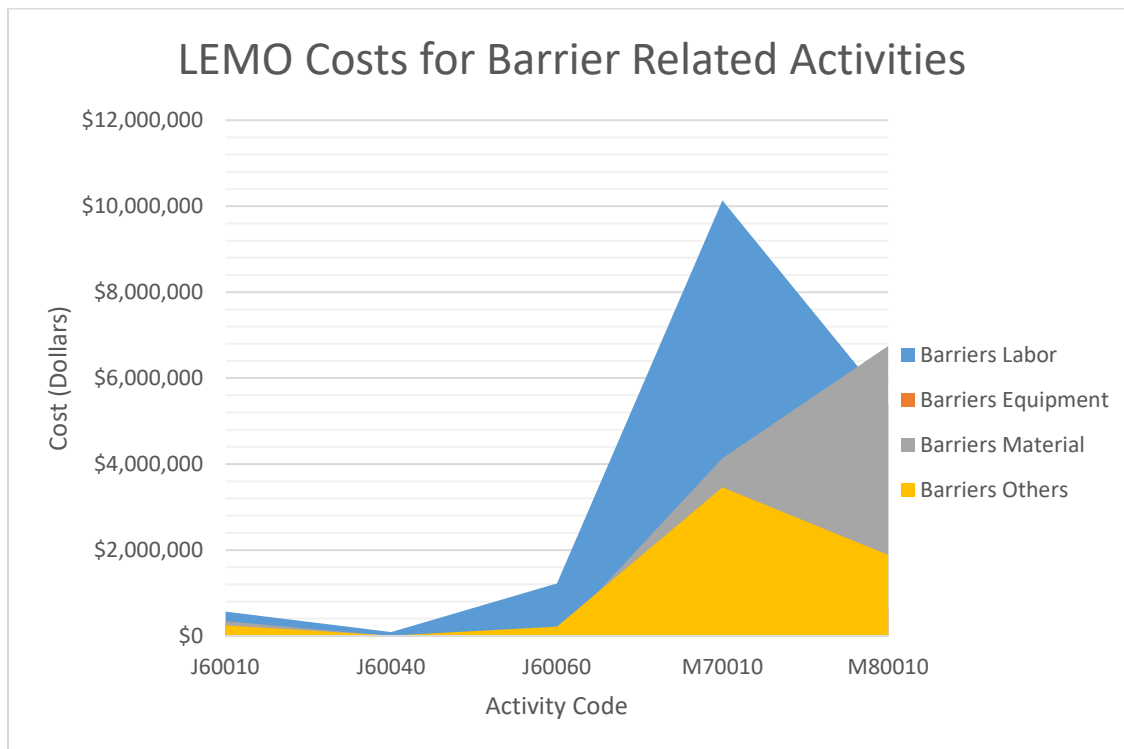

Figure 3.2: LEMO Costs for Barrier Related Activities.

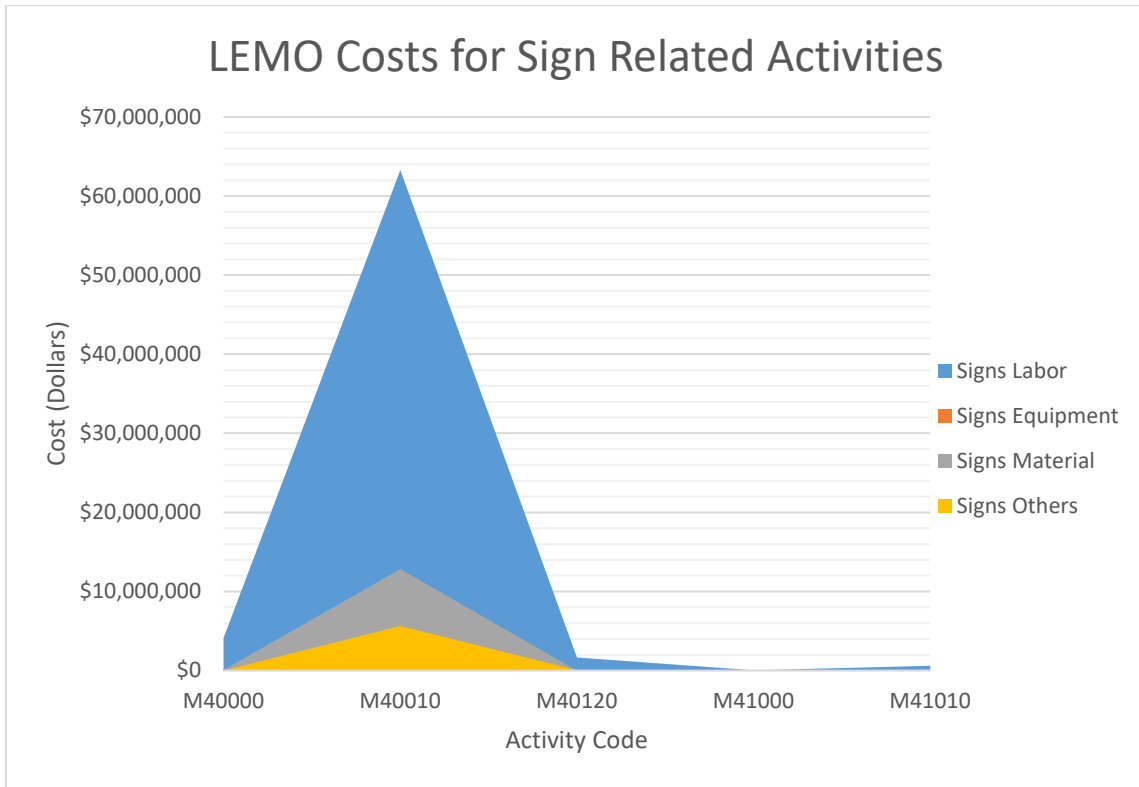

Figure 3.3: LEMO Costs for Sign Related Activities.

Performance Measures for Roadside Features

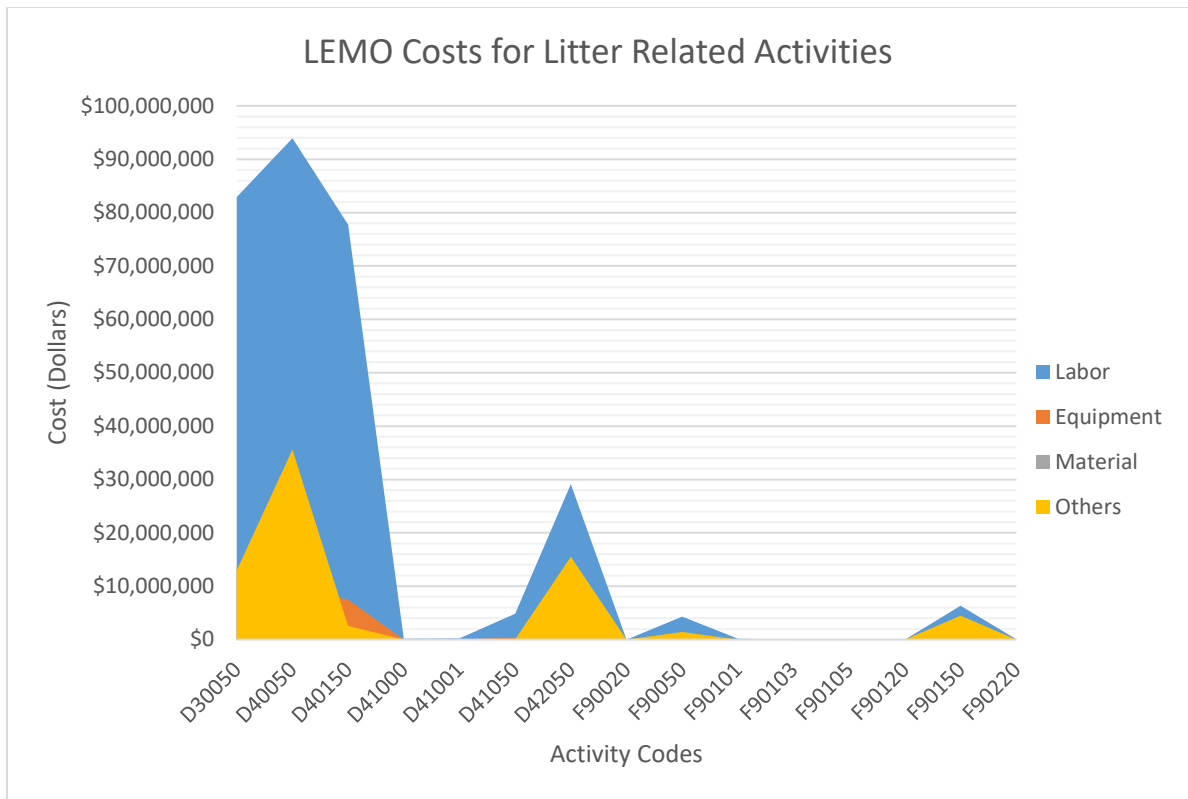

Figure 3.4: LEMO Costs for Litter Related Activities.

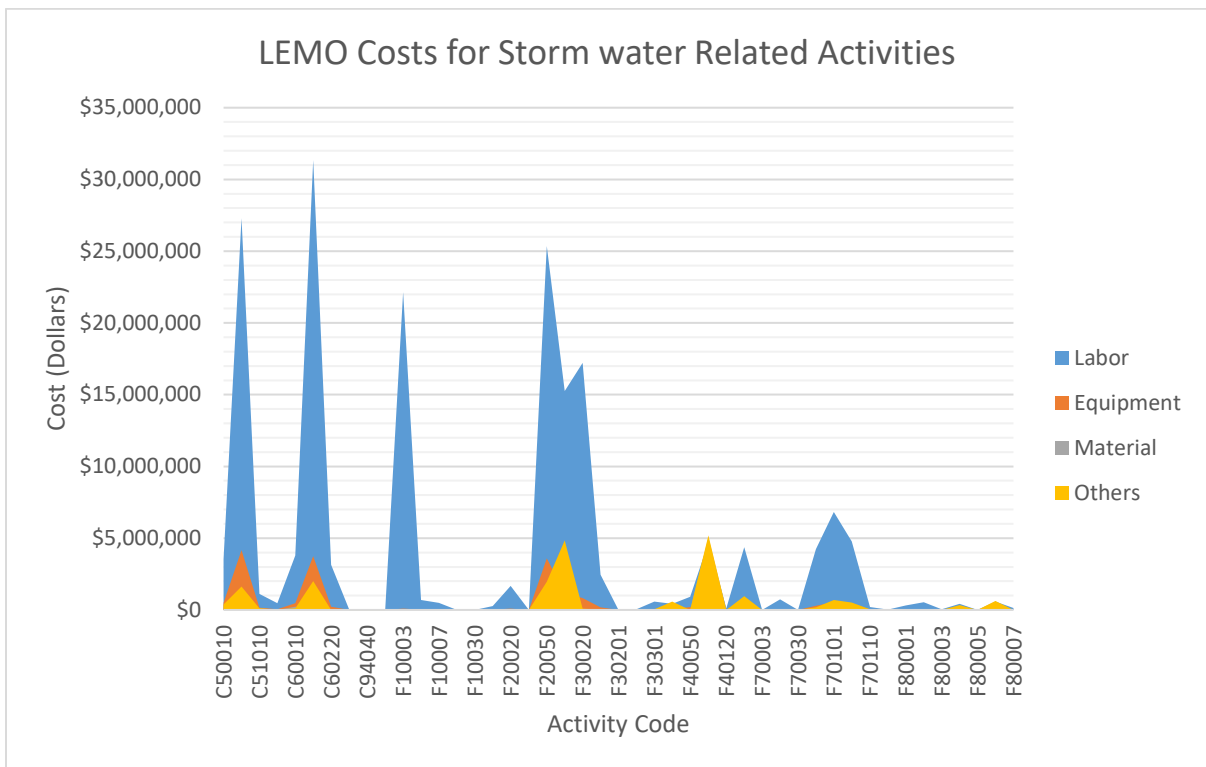

Figure 3.5: LEMO Costs for Storm Water Related Activities.

Performance Measures for Roadside Features

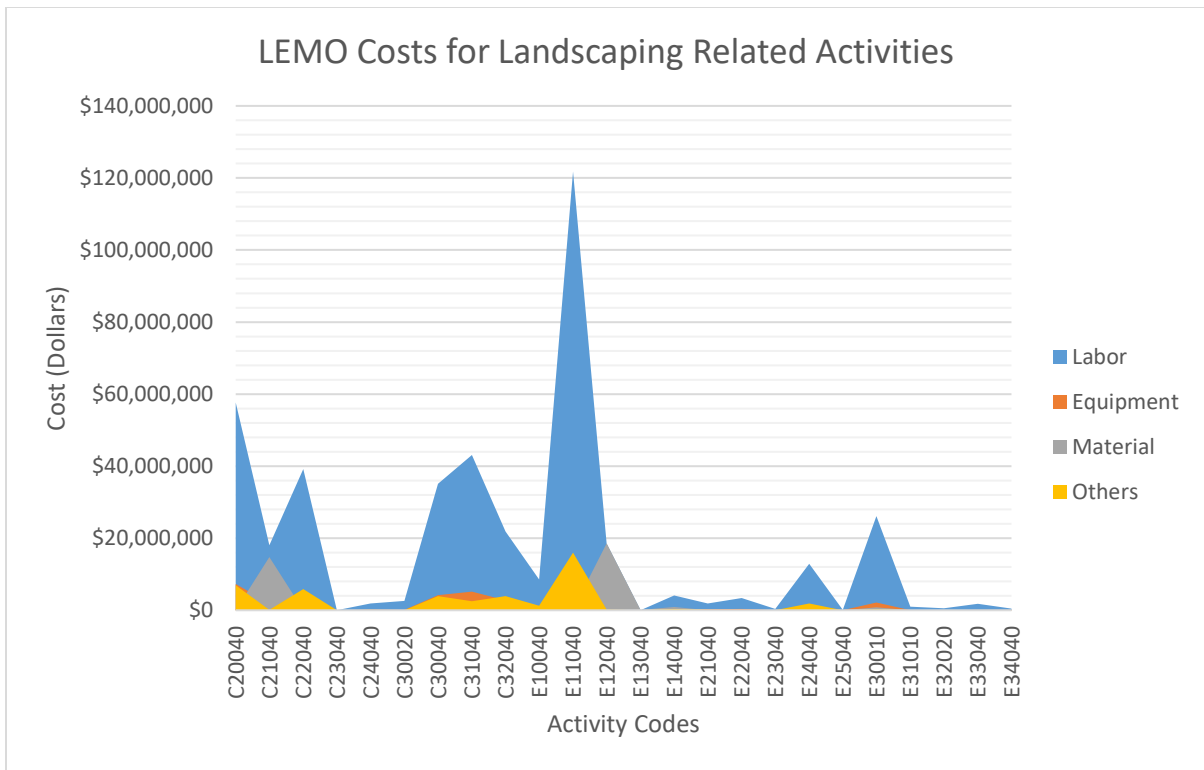

Figure 3.6: LEMO Costs for Landscaping Related Activities.

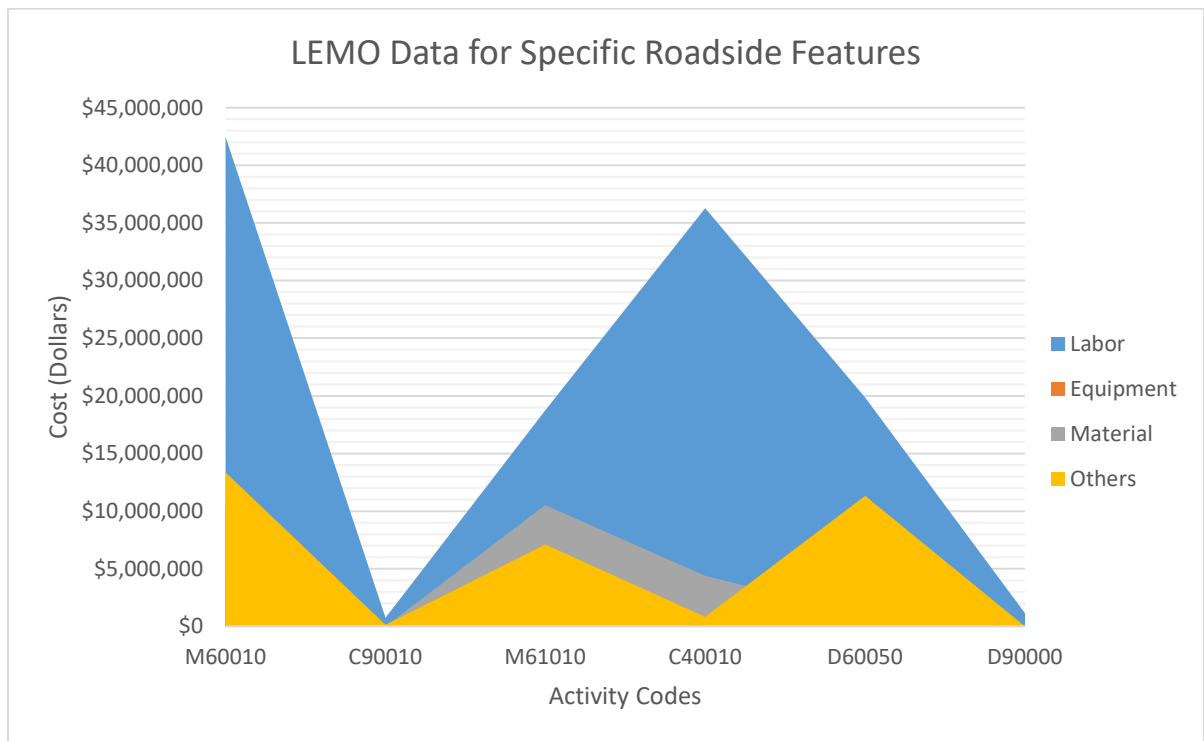

Figure 3.7: LEMO Costs for Guardrails, Sound Walls, End Treatments, Fencing, and Graffiti.

Traffic Collision Report Data

When a collision occurs on a California highway and is reported to the California Highway Patrol (CHP), a report is written by the attending CHP officer and systematically processed. Much of the non-PII data is stored in a Caltrans database called “Traffic Accident Surveillance and Analysis System” (TASAS). It is in this database where detailed data on all highway collisions is retained and subsequently used by Caltrans and other interested parties. Detailed information about TASAS and Traffic Collision Reports can be found in Chapter 3 of the “California Traffic Manual’ (1996 Metric Version with updates) as effective on May 19, 2004.” TASAS contains the precise location of the collision (county, route number, post mile marker value, and side of the highway) along with the date, time, type of collision and other associated details. Note that TASAS contains only the essential details of all highway collisions where the injury information, collision diagrams, and CHP/witness/driver statements are retained in the original pdf format report. Any information on collisions damaging or colliding with Caltrans roadway features may or may not be included in the narrative, diagrams, or “form” data depending on the discretion of the CHP officer.

From 2016 California highway Traffic Collision Reports, the following results indicate the significance of roadside features in highway accidents:

20% of all collisions were categorized as “Hit Object” yet they rank highest amongst all collision types for all fatalities at 35% (see Figure 3.8). Comparing this relationship between the frequency of collisions and fatalities illustrates the severity of “Hit Object” collisions. Specifically, when comparing these collisions to “Rear-end” collisions, which account for 50% of all collisions but only 15% of fatalities.

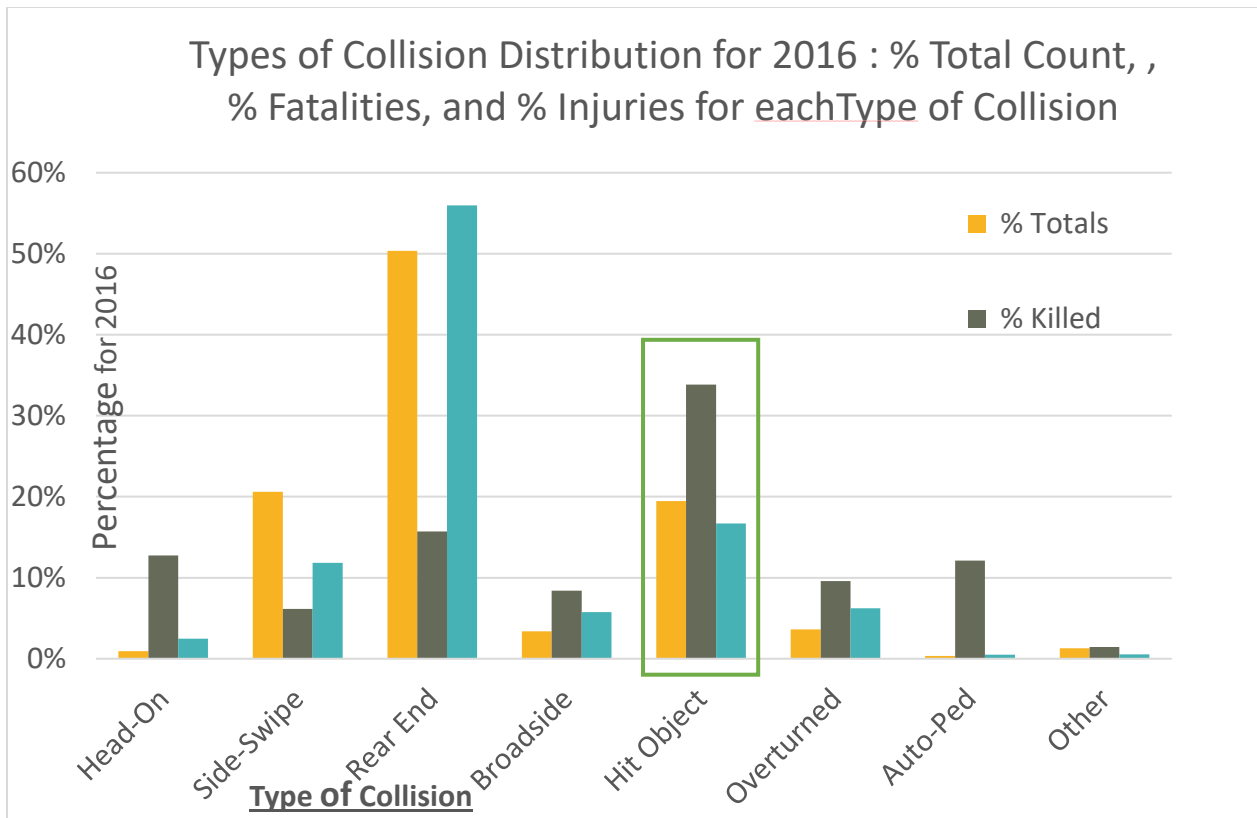

Figure 3.8: Bar chart of collision types for 2016 along with their associated fatalities and injury distribution.

To obtain additional details on the objects that are impacted, there is another piece of information available on the Traffic Collision Reports. On the second page of the Traffic Collision Report, there is a section where the attending police officer from CHP can describe what the primary vehicle was involved with. In Figure 3.9, an excerpt from a TCR shows that a “Hit Object” type of collision occurred, and the primary vehicle involved with a “Fixed Object.” In the space following the check mark box, the CHP officer writes in his/her description of the object. For 2016, approximately 17% of all the traffic collision reports were checked “Fixed Object,” and there are approximately 3400 sets of unique phrases/words that CHP officers had written.

Independent of collision type, 17% of all primary vehicles were involved with a “Fixed Object.” Figure 3.10 illustrates the distribution of the fixed object description from the attending CHP officer. Note from Figure 3.10 that 49% are involved with barriers (defined for this analysis as any rigid cement structure) and 19% were involved with a guardrail or attenuator.

TYPE OF COLLISION	
<input type="checkbox"/>	A HEAD-ON
<input type="checkbox"/>	B SIDE SWIPE
<input type="checkbox"/>	C REAR END
<input type="checkbox"/>	D BROADSIDE
<input checked="" type="checkbox"/>	E HIT OBJECT
<input type="checkbox"/>	F OVERTURNED
<input type="checkbox"/>	G VEHICLE / PEDESTRIAN
<input type="checkbox"/>	H OTHER:
FT.	
MOTOR VEHICLE INVOLVED WITH	
<input type="checkbox"/>	A NON - COLLISION
<input type="checkbox"/>	B PEDESTRIAN
<input type="checkbox"/>	C OTHER MOTOR VEHICLE
<input type="checkbox"/>	D MOTOR VEHICLE ON OTHER ROADWAY
<input type="checkbox"/>	E PARKED MOTOR VEHICLE
<input type="checkbox"/>	F TRAIN
<input type="checkbox"/>	G BICYCLE
<input type="checkbox"/>	H ANIMAL:
<input checked="" type="checkbox"/>	I FIXED OBJECT: K-rail
<input type="checkbox"/>	J OTHER OBJECT:
PEDESTRIAN'S ACTIONS	

Figure 3.9: Excerpt from a Traffic Collision Report Form where the attending CHP officer indicates the “Type of Collision” and the “Motor Vehicle Involved With” designation for the collision.

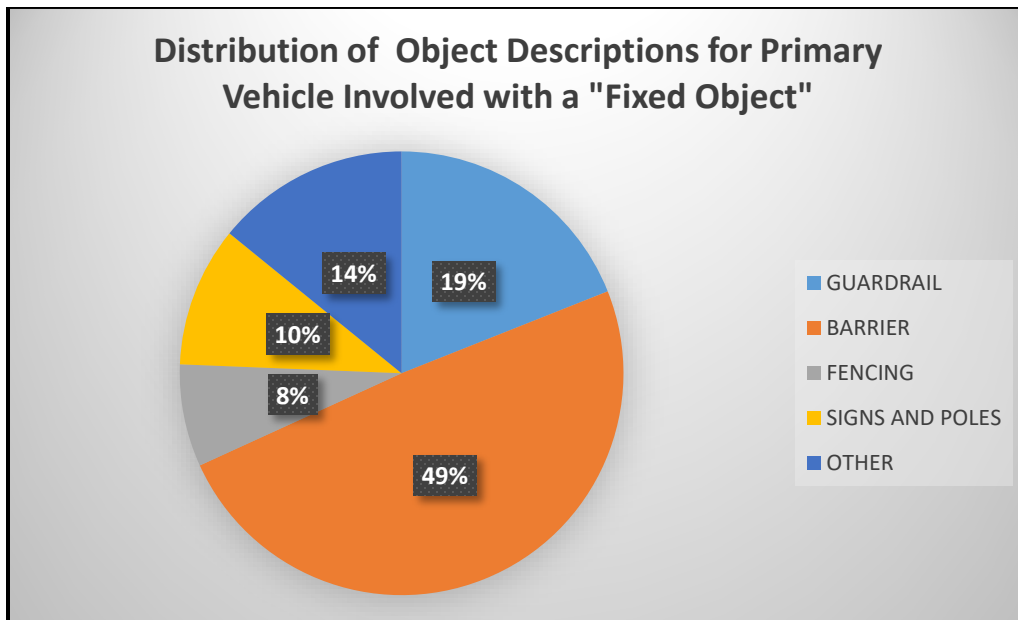

Figure 3.10: Distribution of Object Descriptions when the Primary Vehicle is involved with a "Fixed Object." This narrative description of the object is denoted in the Traffic Collision Report.

Lane Closure System

The Lane Closure System (LCS), an Oracle database that tracks all information related to planned lane closures from Caltrans maintenance, construction, and encroachment permits, fields activities on the State Highway System. Thus, this database is a mechanism indicating the presence of a work zone on a state highway. The Caltrans Division of Traffic Operations was extremely helpful and provided downloads from the years 2010-2015 when asked for access to the data. More recent data was also available, but since traffic collision data was not available after 2015 at the time of this research, it was decided to limit the LCS data to this same timeframe (2010-2015). The fields contained in the LCS data are shown in Table.

Table 3.3: Field names and corresponding description for data in the LCS.

<i>LCS Field Name</i>	<i>Description or possible answers</i>
District	1 to 12
Submitted by Branch	Encroachment permit, Maintenance, Construction
Project No	Provided by Caltrans
Start	Planned (date and time) Start of field activity
End	Planned (date and time) End of field activity
Duration	“Standard” or other
Closure Id	Assigned attribute
Log No	Relates to the number of entries for each closure
Request Status	“Approved” (otherwise there would be no lane closure)
Current Status 1097	Y if the lane closure started
Current Status 1097 Date	Corresponding date to above
Current Status 1098	Y if the lane closure ended
Current Status 1098 Date	Corresponding date to above
Current Status 1022	Closure canceled “in the field.”
Current Status 1022 Date	Date if 1022 Status= “Y”
Route No	Same system as TASAS
Direction	Same system as TASAS
Begin Post Mile	Same system as TASAS
End Post Mile	Same system as TASAS
Facility	Supplied by Caltrans
Total Existing Lanes	Same system as TASAS
Types Of Closure	Road work details
Closure Details	Road work details
Type Of Work	Road work details

Table 3.3 shows that there are a number of data fields that seem very similar to those found in the other databases. It is helpful to know that the LCS is a dynamic tool where all Caltrans related lane closures are managed. Thus, advanced planning information is present along with project management activities and daily operations which encounter a multitude of challenges. The codes include the following:

Performance Measures for Roadside Features

- 1022 is when a closure is canceled in the field
- 1097 is when the crew places the 1st cone on the traffic lane (begin time)
- 1098 is when crew removes all the cones from the traffic lane (end time)

To identify which records in the LCS refer to actual lane closures (as opposed to planned but not realized), the following is a guide as to which rows should be designated as “active/actual” and the others as “planned but not executed”:

- If a scheduled closure is not canceled and there is a start time but not an end time, you assume the closure happened.
- The start and end fields indicate the planned closure start time and may not indicate the actual start of the closure. The start date and end date are when a closure is allowed for that work. The actual start time and end time should be within that range.
- The first two digits of the construction contract number identifies the district where the project is located.
- Start and end Post Miles are where the actual closure starts, not where there are advanced warning signs.
- Construction project numbers have a Begin County name and End County name as well as a route.
- For maintenance projects, each “project number” is associated with a crew in that district.

Information on lane closures with respect to IMMS data, however, is only possible when the precise post mile value can be extracted from the IMMS work order records. In its current state, some processing of intelligent programming needs to be developed to tie the two systems together.

Enterprise

Enterprise datalink can be found in Caltrans’ database by accessing the CT Pass system. It is like IMMS LEMO data in that Enterprise also has options to extract cost data by fiscal year. However, Enterprise results use a different coding system. Specifically, searching by Labor Expenditure Summary by fiscal years the results are sorted by PEC codes. There are many other options to extract data in Enterprise that have yet to be fully investigated. A sample of the data obtained from Enterprise from Labor Expenditure Summary is shown in Table 3.4.

Table 3.4: Enterprise Labor Expenditure Summary for Fiscal Year 2017

FY	Dist	Element	PEC	PECT	Appr	Tot Hrs	Tot \$
2017	01	2080	2080315	000	16001	10.00	957.67
2017	01	2080	2080380	000	16001	12.00	1,027.29
2017	01	2080	2080220	000	16001	146.00	8,655.72
2017	01	2080	2080110	000	16001	21.00	775.34
2017	01	2080	2080110	000	16001	27.00	2,375.89
2017	01	2080	2080110	000	16001	28.00	2,537.91

Performance Measures for Roadside Features

2017	01	2080	2080410	000	16001	44.00	2,433.44
2017	01	2080	2080240	000	16001	18.50	763.97
2017	01	2080	2080525	000	16001	114.50	4,739.71

Integrating all the Codes

Just from reviewing Service Requests and Work Orders, there are various coding systems that contain useful information about roadside features when integrated together. Activity Codes from Service Requests would allow further analysis based on the type of maintenance activity that is being requested. These codes being related to Work Orders would then combine together and allow extraction of LEMO data based on Activity Codes. It was mentioned that the IMMS system was being updated, but in the future, all these codes and databases of information will need to be integrated together to relate specific roadside feature incidents that relate directly to cost.

CHAPTER 4: IDENTIFIED ROADSIDE FEATURES

One primary objective of this research is to develop a list of specific roadside features that have a significant impact on worker safety whether by means of exposure as a function of time and location. During this research, many discussions occurred with maintenance workers throughout all 12 Caltrans Districts. A number of roadside features were identified as being “high maintenance” in terms of time exposed to high speed traffic by those who performed the actual work. In general, it is felt that “maintainability” is not considered in the design and cost assessment of roadside features. If maintenance resources were included in the cost-benefit analysis of roadway design, then, it was felt by most of the field workers, many features would be designed differently. The outcome of this research was to identify these roadside features and recommend ways, whether through design or policy, they could be modified and how these modifications could be applied.

Meetings with District Maintenance Personnel

A critical portion of this research was to understand and identify the areas where Maintenance felt that forethought or initial design could be better, areas of excessive or unnecessary exposure, avoidable risks, and just a better way of doing their jobs in general. We traveled around the state to get a sense of the unique issues each District faces and had phone conversations with other districts. The research team was able to visit and discuss with the maintenance personnel at Districts 2 (Redding), 3 (Marysville), 4 (Oakland), 5 (San Luis Obispo), 6 (Fresno), 7 (Los Angeles), 8 (San Bernardino), 10 (Stockton), and 11 (San Diego). We were able to teleconference with Districts 1 (Eureka), and 9 (Bishop) but not yet with district 12.

In preparation for each meeting with the different districts, we described the purpose of the meeting and sent them a list of topics we would like to cover. This list was also used to initiate a conversation between the research team and the maintenance experts. The list is:

- Which roadside features require a large amount of your resources? This can refer to the amount of time, man-hours, repair costs, equipment usage and risk to workers. Thinking of these:
- Which ones cause you the most challenges?
 - Is there a different design (material, feature and/or placement) that would help reduce these challenges?
- Does your district have unique challenges and if yes, what are they?
- Does your district have practices/policies/plans that your district follows which can help other districts reduce the issue?
- What ideas do your field workers have to improve worker safety when maintaining roadside features?

What can Caltrans change, remove, or adopt to benefit safety and maintenance of roadside features in general?

Synthesis of Roadside Features Maintainability

During this research, it became evident that local environments and conditions play a significant role in Caltrans maintenance operations. California highways exist in most types of conditions possible from high altitude mountains with extreme winter conditions to desert regions, ranging from sparse to dense population areas. There are many high population density cities and low population areas along rugged coastlines in this state where the population keeps growing and demands on the state highway system are ever increasing. Each Caltrans District Maintenance Division had a great deal to say about the challenges they face when maintaining roadway features that need regular attention, repair, and replacement. This section attempts to encapsulate all the issues discussed surrounding the “maintainability” of roadway features.

From the collision data discussed in Chapter 3, no conclusions can be drawn at this point until further effort is dedicated to determining the post mile location data associated with each IMMS record. Currently, the location of maintenance work done and documented in IMMS is described regarding landmarks and vague terms which are not easily converted into post mile location data.

Further insight into where Caltrans resources are expended on which types of operations can be obtained by evaluating LEMO data. In 2017, the total dollar amount spent on each roadside feature of interest is seen in Table 4.1. For each roadside feature named, the percent of total cost for labor and materials is shown along with the roadside feature’s percentage of total costs among the list of roadside features displayed below. From Table 4.1 the total LEMO costs for identified roadside features is over \$30 million. With respect to the total costs expenditure, Figure 4.1 illustrates the distribution of maintenance work involving roadside features. It can be seen from Figure 4.1 that 54% of total costs are dedicated to both landscaping and debris pickup. Although “litter and debris” is not a roadside feature, it exists and should be noted, especially when working on roadway safety features, such as guardrails and barriers, utilizes only 11% of total LEMO costs.

Figure 4.2 depicts how labor and materials cost are utilized for each roadside feature. It can be seen in Figure 4.2 that work done on Guardrails, Barriers and End-Treatments has no more than a 20% gap between labor and materials expenditures. All other categories have at least a 40% difference between labor and material expenditures. Since the majority of expenditures goes toward labor costs, it can be surmised that there is a great deal of Caltrans labor exposure to high-speed traffic.

Table 4.1: Table of LEMO for Selected Roadside Features. Shown are the total number of Work Orders for 2017 along with the total LEMO, Labor and Maintenance costs, and the average cost per work order.

RSF Name	Total number of Work Orders	Total LEMO cost	Total Labor cost	Total Materials Cost	Total LEMO cost per Work Order
Guardrails and Barriers	8,996	\$ 3,193,534.62	\$ 1,053,987.10	\$ 560,352.90	\$ 354.99

Performance Measures for Roadside Features

End Treatments	3,372	\$ 905,580.15	\$ 345,132.71	\$ 233,056.67	\$ 268.56
Landscaping	38,546	\$ 8,186,018.31	\$ 6,765,758.57	\$ 285,429.00	\$ 212.37
Storm Water	30,683	\$ 3,096,169.46	\$ 2,429,492.86	\$ 41,619.13	\$ 100.91
Signs and Poles	19,575	\$ 1,413,779.15	\$ 1,071,755.38	\$ 169,557.78	\$ 72.22
Sound Walls	69	\$ 301.92	\$ 295.24	\$ -	\$ 4.38
Fencing	6,670	\$ 992,952.50	\$ 787,426.80	\$ 114,260.11	\$ 148.87
Lighting	33,208	\$ 2,385,566.12	\$ 1,434,915.70	\$ 343,998.17	\$ 71.84
Traffic Signal	41,199	\$ 1,368,919.47	\$ 844,977.62	\$ 287,560.16	\$ 33.23
Ramp Meter	10,571	\$ 302,005.78	\$ 209,575.04	\$ 53,166.76	\$ 28.57
Litter, Debris, Trash	35,705	\$ 7,906,127.32	\$ 6,534,177.52	\$ 1,970.54	\$ 221.43
Graffiti	7,128	\$ 410,077.37	\$ 360,768.84	\$ 17,448.96	\$ 57.53
Totals	235,722	\$ 30,161,032.17	\$ 21,838,263.39	\$ 2,108,420.18	

Performance Measures for Roadside Features

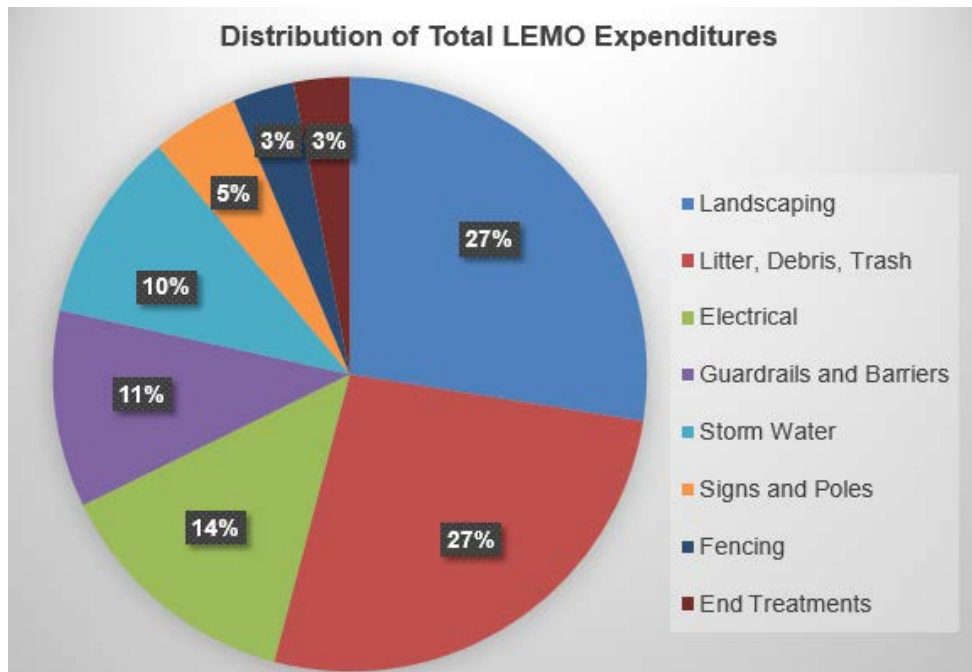

Figure 1.1 Total LEMO Costs for key roadside features.

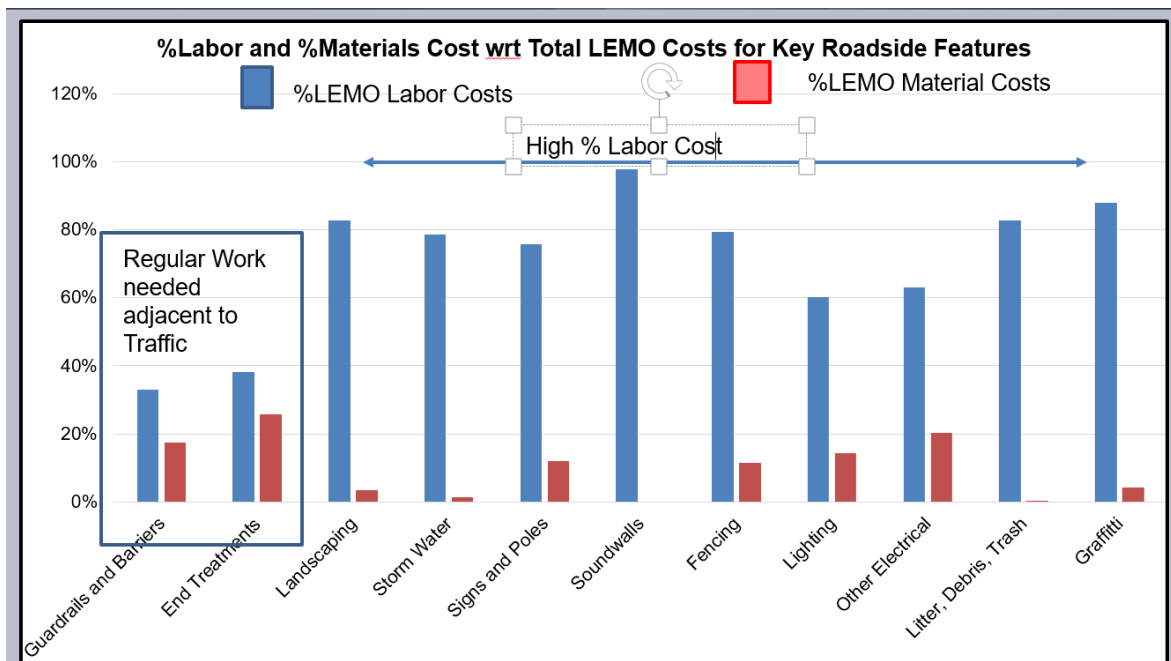

Figure 4.2: Bar Chart of both Labor and Materials Cost % for the Indicated Roadside Feature.

Guardrails and Barrier

According to IMMS data for 2017 (Table 4.1), the average cost per work order is the highest of all roadside features at \$359. The average cost per work order of those shown in Table 4.1 is \$140. Considering the ratio of labor costs and material cost, this indicates that there are opportunities to be had with respect to which type of guardrail is used. The labor and material costs seem to be reasonable since both guardrail parts as well as the labor to fix them are both high. This indicates that labor costs are not necessarily overabundant, but there could be cost savings looking at the life cycle of the roadway. If worker safety is factored in multiplied by a risk factor of working in a high-risk environment, then the elevated amount of labor time as factored into a cost-benefit analysis might show real benefit.

Although there is no single data source to indicate which guardrails may show a cost benefit over the life of the roadway by replacing it with a concrete barrier, a cost-benefit analysis can be performed for a specific location. To assist local maintenance supervisors to determine whether a guardrail could be replaced cost effectively with concrete, a cost-benefit tool could be developed to assist in this decision.

To develop a cost-benefit tool, the objective would be to identify if a guardrail could be cost effectively replaced with a concrete barrier. It is assumed a guardrail already exists and no design process is involved. The collision history of the guardrail along with the labor times would determine the risk factor that should be applied to labor costs regarding hours exposed. The total cost of the concrete barrier over the expected life cycle would be compared with the IMMS LEMO costs per year times the risk factor. Storage costs for guardrail parts and any downtime should also be factored in. Other labor costs that should be factored into the equation are the weed management of the guardrail.

Other issues that will need consideration are:

- When a guardrail or any other roadway feature needs to be replaced, a policy determines that the feature be replaced with “in kind.” Thus, the replacement of a guardrail will need to put forth additional resources for a policy exception, if possible.
- The design and location of median barriers is especially problematic due to the additional challenges of accessing the median as well as higher risk of working within the proximity of high-speed traffic. These local environmental factors would increase the risk factor costs.
- There are pros and cons of wood vs. metal support structures for guardrails that are dependent on the local environment.
- Weed control treatments beneath structures presents challenges to Maintenance and are a source of worker exposure.
- For locations where a guardrail is determined favorable to a concrete barrier, minimizing the selection choices should be considered. A minimal amount of repair

time should be sought during the repair of a guardrail and streamlining the part selections would benefit expertise development.

- Storm water capture and litter management also needs to be factored into both sides of the equation.

End Treatments for Guardrails and Barrier

The total LEMO costs for End Treatments is under \$1 million; there may be some financial impact on the repair and replacement of any given guardrail or attenuator. Again, labor costs would be multiplied by a risk factor for the work crew who work adjacent to high-speed traffic. In addition to the risks involved, it has been strongly indicated by maintenance workers that end treatment selection be reduced to fewer in number. How to reduce the number of end treatments is not straightforward and needs further investigation.

A cost-benefit analysis of when and where an end treatment should be replaced will depend on the original design of the guardrail or attenuator itself. The other inherent design inefficiencies may need to be determined in a task group identifying the parts available in storage, and compatibility with existing hardware. Wherever design efficiencies can be improved, it is felt that overall savings to the state of California might be achieved. Some considerations when streamlining the number of end treatment designs:

- Currently, each district needs to maintain a wide variety of end treatments, estimated to be between 10 and 20, which affects the timeliness of repair, storage problems, and additional training.
- Some end treatments are more difficult to repair and/or replace than others due to technical complexity or having insufficient workroom in which to work safely.

Landscaping

As discussed in Chapter 2, there are many issues surrounding landscaping and its implementation along California highways. These include water conservation, environmental health (air, soil, wildlife, and water), beauty, fire protection, and the use of native plants. It should be noted, however, that landscaping total LEMO costs are over \$8 million, making it the most expensive roadside feature for Caltrans to maintain. Also, since 80% of the cost goes towards labor, it appears that design changes may help alleviate this condition. LEMO costs in this category also include work on irrigation, which will be discussed in the following section.

One critical issue voiced by all is the current design of our roadways does not take into consideration the maintainability of landscaping during the design process. It is felt that if labor costs and risk factors were factored into cost-benefit analyses of landscape design, then many labor hours would be saved with “smarter” designs.

A number of cost-benefit analyses need to be developed when considering landscape design practices. Although many dependencies are identified here, it is felt that much more information is needed before an adequate cost-benefit analysis mechanism can be derived. Beginning with

weed management, there are several treatment strategies in place. In general, however, it is felt that weed mats do not work. They decompose in the sun and have a limited life and can cause additional work when present. Semi-permanent anti-weed solutions are desired such as non-structural concrete, but storm water management can be problematic. Other weed control methods such as the regular application of herbicides are also considered environmentally unfriendly and can cause additional risk to the field worker if not following proper procedures and protocols taught annually by the Department. One solution could be a balance of concrete as well as a mixture of native plants to keep invasive weeds out, allow for drainage into the soil, etc.

Hardscaping in lieu of landscaping is preferred by field crews due to its ease of maintenance. Although hardscaping is considered expensive, many in maintenance believe that it may be a cost-effective solution in many harsh conditions where water availability is low, and chances of wildfire are high. A cost-benefit tool that incorporates LEMO costs over the life cycle of a hardscape product would be beneficial. There could be other savings, however, with a hardscape solution such as litter control, general cleaning, and irrigation costs. The downsides to hardscaping, which should also be considered, are storm water control and graffiti.

In general terms, community involvement is frequently active in the selection of landscaping vs. hardscaping elements. Being sensitive to the needs of the community are important, but it is difficult to incorporate into a cost-benefit model. Other issues that are equally problematic are:

- Due to the typically long growing seasons here in California, keeping landscapes trimmed away from the roadway can be difficult to manage. Maintenance workers feel insufficient growth space is allocated, frequently putting workers in problematic areas.
- The shoulder width is generally insufficient to provide a safe working scenario for the road workers who are doing the actual landscaping work.
- Community restrictions or demands play an influential role in the design and maintenance of all landscaping. Frequently there is little recourse for Caltrans to have design influence.
- Native landscaping and drought tolerant landscaping may make sense with respect to water use but could conflict with other issues such as encouraging illegal encampments, infrastructure theft, or trash retention.
- There is frequent landscaping around trees shrubs, and sign posts which must be maintained by hand.

Irrigation

Irrigation design is one area where many design improvements can be made, and many suggestions were provided by the maintenance experts. In general terms, it was felt that irrigation is not designed nor implemented with maintainability in mind. For example, sprinkler heads are frequently installed adjacent to the shoulders. If sprinkler heads were offset from the active throughway, the worker would assume much less risk from the highway environment. This logic

Performance Measures for Roadside Features

could be applied as a general best practice and cost-effectiveness would not be the main consideration.

Another consideration for general improvements towards reducing the amount of labor in irrigation maintenance is to provide simpler irrigation systems that use less water and are less exposed. In regions where the homeless community interferes with above ground irrigation systems, an underground drip system that is protected from root growth would be beneficial. These subsurface systems might also be an ideal supplement to native plantings where water control would be kept to a minimum and potentially irregular, depending on the system and local climate conditions.

Changes to irrigation systems might be considered when an entire landscaping is being replaced. Since both irrigation systems and landscaping, in general, are costly, a cost-benefit analysis tool might not be needed other than as a design tool for future planning. Detection systems can be installed to “show” where irrigation parts are located. Apparently, there is frequently no documentation on current irrigation systems and much labor time is used in “finding” and tracking down parts and locations when maintenance is needed.

Storm Water and Trash Capture Devices

Like landscaping, storm water maintenance work is 80% labor and also adds to the total LEMO costs of over \$3 million. These high labor costs were strongly reflected in the discussions with Caltrans maintenance. There are effective design practices in place, but the implementation of certain types of hardware may need to be investigated. This may be one area where local expertise could help a designer to choose between alternate hardware or fixtures that provide the same functionality. Optimal storm water system hardware selection can significantly depend on local environmental conditions as well as local topographical characteristics, such as soil condition, clay content, the probability of flash flooding, etc.

The labor-intensive operations of drain cleaning (such as slotted drains) are problematic and provide for high-risk work environments. For example, when trying to clean slotted drains, a worker must frequently get down on his/her hands and knees while being in close proximity to high-speed traffic—which is a high-risk situation. When evaluating the cost-benefit of alternate hardware, the risk factor on labor costs should be considered. Other issues to be considered during a cost analysis:

- Clearing of clogged drains is frequently done by hand and cause high worker exposure during the process. Slotted drains were enthusiastically identified as a prime example.
- Due to increasingly inadequate shoulder room on highways in general, there is insufficient space for maintenance trucks to park near a plugged drain to alleviate flooding. Pull-outs for maintenance trucks should be designed in when the shoulder room is minimal.
- All storm water systems create unique challenges during both dry and wet seasons, and their design, function, and placement are not a “one size fits all.” Local input from maintenance will be needed for cost-effective solutions.

Performance Measures for Roadside Features

- Pump houses should be equipped with automatic electronic notification when there is a malfunction to avoid potentially dangerous flooding conditions.

Signs

Sign and post maintenance is another roadside feature that requires mainly manual labor. The total LEMO costs are \$1.5 million. MUTCD and other policies regulate the placement and structural requirements of signs and poles. Since there are many signs in the CRZ, a cost-benefit analysis could be done to see whether a special quick-change sleeve to improve repair times could be installed. Currently, accident data from Traffic Collision Reports do not capture a sufficient amount of sign damage. When minor damage is done, there is generally no official documentation. Signs which have regular impacts could be identified at a local level where the damage rate could be more accurately determined.

It is not certain currently whether sign repair is predominantly due to vehicle impact, or if environmental conditions putting wear and tear on a signboard is an equal component. Fire, sand, wind, sunlight, and vandalism may have a substantial impact on signs.

Sound Walls

Although not typically prone to regular maintenance work, a substantial amount of comments concerning sound walls were given by maintenance workers. LEMO costs are relatively low for sound walls, but landscaping maintenance costs might be minimized if the placement of sound walls were set on property lines. If that is not possible, then any action to “sign over” land use rights to private parties would eliminate a problematic maintenance struggle. Other policy modifications may be implemented, such as employing anti-graffiti measures like irregular rough surfaces, ivy, or allowing local artists to paint a mural on the surface. Of primary concern is the elimination of access behind sound walls which occurs when the sound wall is not placed directly on the right-of-way line. Fencing is another concern when it is not tied into the sound wall and nearby bridge abutments allowing opportunities for illegal encampments.

Fencing and Access Issues

The LEMO data for 2017, as shown in Table 4.1, shows fencing to be less than \$1 million. Considering fencing and access control locations are generally out of the CRZ, it may indicate that the majority of this \$1 million could be prevented if other measures were employed.

A cost-benefit analysis would include the replacement costs of hurricane fencing, which is easy to cut with a bolt cutter. Theft of long stretches of fencing is a problem in some regions where pedestrians may cut holes for easy “pass through.” Further study should be spent on whether a fine mesh fencing would prevent bolt cutters being used and whether any substitute cutting tool would be employed. To help prevent theft, some form of recognizable “tagging” would help to prevent resale of stolen fencing material.

Electrical

Lighting, Ramp Meters, and Traffic Signals show LEMO costs to be over \$3.5 million with over 60% from labor costs. Again, there are many policies that govern the placement and functionality of these devices. This labor cost might indicate efficiencies could be obtained if smarter structural mounting poles were made to be easily changeable. For example, as in the case of the “sign” roadside feature category, there may be a way to install a sleeve of some sort for easy swapping. With electrical systems also involved, however, this may be a difficult task.

A policy change that might benefit maintenance is to ensure any unnecessary electrical boxes or cabinets are placed as far away from the CRZ as possible. Providing pullouts as well as expanding shoulder room is also suggested. Copper wire theft continues to challenge some districts. Making access to covers to be impossible without professional heavy-duty equipment would prevent most of the theft but make it harder for maintenance crews to work. The replacement of copper wire with aluminum wire might be a temporary solution because it appears that aluminum wire theft at the present time is minimal.

Litter and Debris

Although not a “planned” roadside feature, trash and debris are an ever present feature of California highways. As can be seen from Table 4.1, the total LEMO costs for debris cleanup is near \$8 million. Policy change considerations and cost-benefit analyses for other planned roadside features should incorporate any mechanism that enables for efficient trash pickup. For example, in the case of landscaping design work, if hardscaping is put in place and further designed to minimize debris build up, then sweepers or other non-pedestrian forms of trash pickup could be used. Any mechanism to make litter pickup safer is beneficial. Also, it should be noted that many of the planned roadside features that need regular attention all need a dedicated pull off space and sufficient shoulder room. Studies dedicated to expanding shoulder width could also show cost savings in reduced times of labor exposed to high-risk environments.

PROJECT PLANNING GROUP CONSIDERATIONS

After problematic roadside features were identified from our meetings with the statewide maintenance groups, a survey was sent out to the Project Planning group members to collect their opinions regarding these identified roadside issues. The purpose of the survey was to prioritize future work in reducing issues for these roadside features. Opinions were collected on priority and which course of action, such as a policy change, needs to take place to address the issue. Priorities were ranked from 1 to 5 with 5 being of the highest priority. The following section discusses the outcome of the survey.

Metal Beam vs. Concrete Guardrail

Currently, each district which has a metal guardrail needing regular maintenance due to reoccurring impacts would like a mechanism to determine when a concrete barrier would be cost effective over the life of the barrier. The priority of this is 4.8. Therefore, a new policy needs to provide some criteria that allow the districts to change the MBGR into concrete based on hotspots and a cost-benefit analysis. Because hotspots are defined differently for Traffic (based on

Performance Measures for Roadside Features

accidents) and Maintenance (mainly hits or damage to rail), a new policy would need to include a specific definition for hotspots. For this kind of new policy, joint criterion would be needed and may consist of Maintenance, Traffic OPS, and Design.

Metal vs. Wooden Posts

The average priority for this topic was 4.5. The post material depends on the energy absorption required for the location, and wood blocks are still required. Providers of the posts and guardrails are determined on politics. There are policies that specify steel posts if the surrounding environment contains potential fuel for wildfires. More information will be necessary to consider disposal costs, lifespan, wood vs. metal landfills, ease of maintenance, weed control, crash performance, etc. to decide the course of action.

Ground Treatments

The average priority for this topic was 3.4. Comments were made that ground treatments are mainly a quality control issue due to bad installation, training, or construction. Rather than requiring a new policy, new criteria on construction inspection and overall training were deemed necessary.

Natina Guardrails

The average priority for this topic was 1.1. Natina guardrail was a low priority issue, but guidance on repairing it will be done through an article and/or adding to the maintenance manual.

End Treatments

The average priority for this topic was 3.8. Because of the new MASH regulations, Caltrans is still integrating new MASH approved end treatments. This issue will be left alone for some time to see if having new MASH approved end treatments will resolve or lessen the issues with end treatments.

Median Design

The average priority for this topic was 3.8. The scale of median design will require a much larger time scale than is set for this project and will remain for now.

Landscape Offset

The average priority for this topic was 3.7. There are already many policies in place that mention landscaping offset, and sometimes the reduction of offset is caused by the widening of roadways. The group has decided that this topic is too broad and must be cut into smaller issues by asking the districts specifically what roadside features are being placed incorrectly (e.g., pull boxes, irrigation, etc.).

Hardscaping vs. Landscaping, Litter and Debris, Median Planting and Design, Homeless Deterrent, Tree and Shrub Placement

All these issues are lumped together because a similar decision was made for all of them. In general, the issues here are too broad and must be redefined by going back to ask the districts to provide more specific input about the recurring issues regarding design (exact assets being put in wrong locations). Litter and debris is also a separate issue from landscaping and should be separated into another category.

Rock Blanket

The issues with rock blankets were a low priority, and the group decided to wait and see if the rock blanket issues get better or worse in the future.

Irrigation Placement

The average priority for this topic was 4.4. Irrigation placement is an issue that will be resolved with training for design and maintenance.

Roundabouts

The average priority for this topic was 3.1. The group decided that roundabout issues should be solved with training.

Slotted Drains

The average priority for this topic was 4.8. The group wants design, maintenance, and possibly hydrology to create new policies to eliminate the usage of slotted drains.

Drainage Access and GSRDs

These two topics will need more research before concluding. This will include a study of how other states handle similar issues in highly urbanized areas with no available space for routine maintenance of these storm water devices.

Smart Pump Houses

The average priority for this topic was 2.4. More information will be needed. Some districts already have systems in place and could be used as an example to send signals to TMCs when pump houses breakdown.

Sound Walls

The average priority for this topic was 4.8. The group decided that there needs to be a policy change for sound wall placements and that a meeting will be necessary between the Divisions of Design and Right of Way.

Sign Posts: Wood vs. Steel

The average priority for this topic was 4.5. It was mentioned that construction does not put in steel posts for signs and that only Maintenance will replace it with steel posts when damaged. This topic will require further research into lifespan, costs, disposal, ease of maintenance, etc.

Modularity of Sign Assets

The average priority for this topic was 4. The group decided that a new policy is needed to produce sign assets that are modular.

Moving Signs Out of CRZ

The average priority for this topic was 4.7. There is a policy in place regarding G-84 signs in the exit gore and alternative signage when repairing existing or installing new exit gore signs. Because of this existing policy, the group decided that training is necessary to uphold this policy.

Anti-Graffiti

The average priority for this topic was 3.4. There is new type 11 sheeting, but there is uncertainty if it has graffiti resistance. The group decided that the Maintenance and Traffic OPS will need to address this issue.

Quick Change Sign Base (Sleeves)

The average priority for this topic was 4.7. Districts 4 and 5 already use these sleeves, and Design, Structures, and/or Construction needs to adopt the quick-change sign bases.

CHAPTER 5: CONCLUSIONS AND RECOMMENDATIONS

The primary objective of this research was to take a broad view of the design and maintenance of California highway roadside features in an effort to improve worker safety through efficiencies that minimize the amount of exposure time in a cost-effective manner. A list of roadside features that present an opportunity for design improvement was developed during this research. These roadside features all share a common attribute of potentially reduced worker exposure time during the life cycle of a highway. These opportunities to improve the maintainability performance are identified in this research.

During this research, many discussions occurred with experienced maintenance workers throughout the state. A number of roadside features were identified as being “high maintenance” as a function of time exposed to high-speed traffic by those who perform the actual work. In general, it is felt that “maintainability” is not considered in the design and cost assessment of roadside features. If maintenance resources were included in a cost-benefit analysis of roadway design, then, it was felt by most of the field workers, many features would be designed differently. Their ideas and suggestions are reflected in these findings where design recommendations or work processes are provided.

A key point that is also relevant is that there is no best practice or policy that can replace the expertise of the people who do the actual maintenance work at their home base. This is especially true in California where there are as many climate and environmental conditions that exist throughout the United States, so that each roadway presents unique challenges and may cause exceptions to any design best practice. Therefore, communication throughout the entirety of the roadway life cycle, from early concept to long-term maintenance, should always involve the local maintenance experts as key stakeholders

The fundamental aim of this research was to take a broad view on the maintainability of roadside features along California highways. This incorporates the initial roadway design work that specifies what roadside features are used and where they are positioned, how much labor/material costs go into the maintenance of a roadside feature, and how much “burden” is put on the workers and traveling public. “Burden” here incorporates unnecessary additional time used for maintenance, proximity to high-speed traffic and availability of personal protection equipment, and finally the time waste to the traveling public due to traffic delays during lane closures. The following are the major observations and conclusions that have been drawn from the research:

- After meeting with the maintenance groups throughout Caltrans, the following roadside feature groups, in general, provide many challenges:
 - Guardrails and Barriers
 - End Treatments
 - Landscaping and Irrigation
 - Storm Water Mechanisms
 - Signs and Poles

Performance Measures for Roadside Features

- Sound Walls
 - Fencing
 - Electrical
-
- Changes need to be made to Policies, Design Manuals, Traffic Ops, etc. that will consider maintenance worker safety on the roadside features mentioned above.
 - It appears that maintainability of a roadway feature during the design phase is not factored into the decision-making process. The total repair cost over the life of the feature should be considered since it provides the best value.
 - IMMS LEMO costs appear to be an excellent indicator of where high labor costs prevail during the maintenance of a roadside feature. These high labor costs reflect the number of hours workers are exposed to high-speed traffic.
 - The data available through IMMS will be invaluable, for it keeps track of hours and material costs of all maintenance work. It will cause some challenges, however, when trying to extract details within “Activity Codes.” For example, “Repair or replacement of barriers or guardrails” does not provide information on why it needed repair or replacement. Sometimes additional comments are present, but these are infrequent.
 - Traffic collision data, at this time, is not generally able to be correlated with roadside feature performance since the “Location” parameter within IMMS is not readily available in terms of county, route, post mile marker prefix and value along with which side of the freeway. More research needs to be done to compare traffic collision data and IMMS data in order to extract the amount of hits on each type of roadside feature and specific location data.
 - Traffic collision reports show that 20% of all collisions are with some roadside feature and of that 20%, 35% result in fatalities.
 - Traffic collision data will be useful when performing a cost-benefit analysis of guardrail exposure to collisions and safety risk assessment for maintenance workers.
 - Due to the dynamic nature in which California highways exist and serve the public, no single set of design guidelines and best practices can replace the knowledge and experience of local experts who perform maintenance work. Consequently, local maintenance experts should always be brought into the very earliest of design planning meetings.
 - Limited shoulder room is a major cause of worker safety and is inadequate in general.

The following is a description of some of the major issues associated with maintenance of roadside features and the recommendations of this research study.

Guardrails and Barriers

The major issues identified in relation to the maintenance of guardrails and barriers are:

- All work is typically performed adjacent to high-speed traffic.
- Repairs and replacements of guardrails and end treatments are complicated because there is a large selection of guardrail/barrier parts for repairs.
- Support structure material (metal vs. wood) and weed treatment methods create additional exposure time for maintenance crews.

Recommendations:

- There is a need for a new policy that will provide a mechanism allowing individual districts to replace heavily maintained metal guardrails with concrete structures. These metal guardrails are in individualized “hot spot” areas which experience regular damage. In the development of a new policy a joint effort between Maintenance, Traffic OPS, and Design is recommended.
 - A cost-benefit analysis study is recommended that can provide a method for life cycle cost estimation that can be utilized in decision-making to choose concrete versus metal guardrails based on requirements at each location. The life cycle cost assessment tool to be developed as part of this recommended study should assist the districts in determining whether a section of guardrail would benefit from a concrete replacement. The life cycle analysis should consider the long-term maintenance savings as well as the improvement in worker safety due to less time repairing guardrails in a high traffic exposure environment.
- There is also a need for a new policy that provides a mechanism for districts to replace wooden guardrail posts with metal posts. Development of this new policy would also require a joint effort between Maintenance, Traffic OPS, and Design.
 - A research study is recommended before the development of the above policy to develop guidelines to objectively support the decision for replacement that would include maintenance costs, fire hazards, weed control, crash performance, and improvements to worker safety.
- To reduce worker exposure to high-speed traffic when performing ground maintenance duties near guardrails, it is recommended that revised criteria be included in the installation specifications and inspection protocols of ground treatments. This criteria should consist of mechanisms that ground treatments are installed correctly at each installation to alleviate the current performance problems with ground treatments.
- Distribution of information on the maintenance of guardrails with a patina finish is recommended. This information can be delivered through a news article and/or added in the Maintenance Manual.

End Treatments

The major issues identified in relation to maintenance of end treatments are:

- A large number of existing end treatments are on the roadway and can lead to additional exposure time due to inexperience.
- Spare parts need to be kept on-hand for repair work, and storage creates additional problems.

Recommendations:

- It is recommended not to address the issue of end treatments at this time. This is because Caltrans is in the process of integrating the new MASH approved end treatments. It is felt that some time is needed to see if having the limited number of MASH approved end treatments will alleviate some of the existing maintenance issues associated with end treatments.

Landscaping and Irrigation

The major issues identified in relation to maintenance of landscaping and irrigation are:

- Maintenance work is frequently done adjacent to high-speed traffic.
- Limited shoulder width increases worker exposure to traffic.
- Guidelines and best practice documents established in the past are not readily available in the current work culture, especially in terms of irrigation placement.
- Drought, fire, water usage, weed control, illegal encampments, watershed, and environmental issues all play a significant role in landscaping maintenance that need to be considered.
- Current policies that address landscaping offsets may be negated as plantings grow with time or when highways get widened, resulting in landscaping encroachment.
- There are several issues associated with landscaping which are “broad in scope,” including landscaping encroachment, use of hardscaping versus landscaping, median design, plantings/shrub placement, and illegal encampment deterrents.
- There were issues with roundabouts in terms of snow removal and conspicuity for the traveling public.

Recommendations:

- More research is needed for maintenance issues in landscaping that are “broad in scope.”

Performance Measures for Roadside Features

- It is recommended that more data to be gathered from districts to provide more specific details of the recurring problems.
- For placement of irrigation systems and roundabout designs:
 - Additional training and education are recommended so that existing policies can be followed.

Storm Water Mechanisms

The major issues identified in relation to maintenance of storm water mechanism are:

- In general, complaints indicate that all Gross Solid Removal Devices (GSRD) are difficult to clean.
- Cleaning and maintenance of slotted drains were identified as a major issue by several districts.
- Access to drains in highly urbanized areas with limited right of way was a major issue for maintenance.
- Notification of malfunctioning devices in pump houses was a problem for some districts, resulting in maintenance delays and degraded performance.

Recommendations:

- A new policy is recommended to be developed by Design, Maintenance, and possibly the Hydrology to eliminate the use of slotted drains.
- It was felt by the Project Planning group that more research is needed to address the issues surrounding Drainage Access and GSRD. Additional research is recommended to study how other states handle similar issues in highly urbanized areas with no available space.
- With respect to “smart” pump houses, there are already some districts which currently have these devices. It is felt that these districts’ experiences could be used to help other districts utilize electronic signals to notify the Traffic Monitoring Center (TMC) when a malfunction is occurring.

Signs and Posts

The major issues identified in relation to maintenance of signs and posts are:

- Use of wooden post by construction for signs increases maintenance requirements.
- Gore points and hot spots put workers in high danger when fixing signs.

Performance Measures for Roadside Features

- There are problems in terms of inventory of components due to lack of modularity of signs and their components.
- Graffiti is difficult to remove.

Recommendations:

- There is a need for a cost-benefit analysis evaluating use of steel posts versus wooden posts for signs that would consider maintenance and disposal as part of the life cycle cost. It is recommended that a research study be conducted in this area. In this recommended study consideration should be given to research into lifespan, costs, disposal, ease of maintenance, etc.
- It is recommended that a new policy be developed to produce sign assets that are all modular.
- There exists a policy memo related to positioning of signs which governs G-84 signs in the exit gore and alternative signage when repairing existing signs or installing new exit gore signs. Additional training is recommended to uphold the current policy governing the use/maintenance of signs placed in the CRZ.
- With respect to anti-graffiti treatments on signs, there is a new “Type 11” reflective coating in place with no knowledge of its anti-graffiti performance. It is recommended that appropriate Maintenance and Traffic OPS groups evaluate the anti-graffiti effects of new type of coating for signs.
- A new policy is recommended to have Design, Structures, and/or Construction adopt a “Quick Change” type of signs with supporting sleeves. Districts 4 and 5 already use “Quick Change” sleeves and posts.

Sound Walls

The major issues identified in relation to maintenance of sound walls are:

- Placement of sound walls with respect to property lines can create a significant set of maintenance issues if there is land behind the wall for which Caltrans is responsible.
- Graffiti removal from sound walls is also a major problem for maintenance.

Recommendations:

- A policy change is recommended for sound wall placement that can eliminate or reduce the problem associated with leaving land behind the sound wall. The new policy should be developed by collaboration between appropriate groups from the Divisions of Design and Right of Way.

Fencing

The major issues identified in relation to maintenance of fencings are:

- Fencing is constantly getting cut, stolen, scrapped, and resold.
- There are access issues due to illegal encampment activity in areas adjacent to fences.

Recommendations:

- Use alternative fencing with finer mesh, anti-cutting razor wire, etc.
- Tagging or marking fencing material to prevent resale.
- Consider security improvements used for irrigation by some districts that may apply to fencing.

Electrical

The major issues identified in relation to maintenance of electricals are:

- Copper wire is constantly being stolen.
- Pull boxes, service cabinets, and electrical housing boxes, in general, are being broken into for electricity by illegal encampment activity.
- There is 24 hour access to State right-of-way for illegal activity to occur.

Recommendations:

- Consider the cost of copper vs. aluminum wiring in hot spot areas because aluminum is cheaper to replace.
- Consider welding electrical boxes to prevent unwanted access. The life cycle outcome of welding should be evaluated since it will cause more trouble for maintenance access.
- Use of tracers or markings for wiring should be considered to prevent stealing and reselling.
- Consider security improvements used for irrigation by some districts that may apply to improve general location security.

Overall Recommendations for Worker Safety:

- Minimizing high labor-intensive maintenance completed near high-speed traffic should be a key objective for safety.

Performance Measures for Roadside Features

- Offsetting worker placement as far away from active travel lanes needs to be maximized.
- Identifying roadway areas where maintenance workers will have a high-risk in maintaining roadside features will be useful so that plans can be considered to improve conditions.
- Factoring-in additional risks to labor and maintenance costs when performing cost-benefit analysis.
- Increasing shoulder width would provide more access and improve worker placement for maintenance functions when appropriate.
- Addressing safety in litter and debris removal operations as a separate issue from landscaping.

Future Work

- Identify a mechanism to calculate “burden” costs, such as worker proximity to high-speed traffic, lost productivity due to traffic delays and lane closures, and the availability of personal protection equipment for the roadway worker.
- Necessary resources should be dedicated for the attendance of local experts to regional and statewide Planning Design Meetings. Incorporating meeting time into key job junctions would support the importance of this responsibility.
- Identify which policy changes can be made to improve maintainability.
- Identify how maintainability can be incorporated into the design and construction bidding process.
- Since hardscaping seems to be a preferred mechanism for landscaping, watershed issues need to be identified and some alternatives found to alleviate these concerns. This is also true when using concrete as a weed deterrent.
- Identify a measure to determine the cost of a roadway feature over the life of the product as a mechanism to help select appropriate roadway features during the design process.
- Develop a risk measure for worker’s exposure to high-speed traffic. Balance this with labor costs.
- Consider public safety and downtime by identifying how much lane closures cost. Will need to bring in CS data.
- Landscaping design improvements are needed but exactly how is unclear.

Performance Measures for Roadside Features

- To align Work Orders and collision data, either translate the verbiage in the location column into post mile values or have the IMMS system prescribe the location field to be marked in terms of post mile markers in a similar method to the LCS. The Accident Problem code cannot always be relied upon since more than 1 collision could occur prior to a guardrail being repaired or replaced
- Further research on topics in “Landscaping” and “Wood vs. Steel” posts to redefine the specific roadside features that need to be addressed.

REFERENCES

1. American Association of State Highway and Transportation Officials, "Roadside Design Guide," *Washington, DC*, 2002.
2. California Department of Transportation, "Highway Design Manual (Hdm)," 2017.
3. California Department of Transportation, "Traffic Safety Systems Guide (Tssg)," 2018.
4. California Department of Transportation, "California Manual on Uniform Traffic Control Devices," 2014.
5. California Department of Transportation, "Standard Plans," 2015.
6. Delaware Department of Transportation, "Traffic Design Manual," 2015.
7. Georgia Department of Transportation, "Design Policy Manual," 2018.
8. Massachusetts Department of Transportation, "Project Development and Design Guide," 2006.
9. Nebraska Department of Transportation, "Roadway Design Manual," 2018.
10. New Jersey Department of Transportation, "Roadway Design Manual," 2015.
11. Florida Department of Transportation, "Fdot Design Manual," 2017.
12. Idaho Transportation Department, "Roadway Design Manual," 2013.
13. Illinois Department of Transportation, "Bureau of Design and Environment Manual," 2006.
14. Montana Department of Transportation, "Road Design Manual," 2016.
15. New York Department of Transportation, "Highway Design Manual," 2017.
16. Pennsylvania Department of Transportation, "Design Manual, Part 2 Highway Design," 2015.
17. W.S.D.o. Transportation, "Design Manual," 2017.
18. Transportation Research Board Executive Committee, "Effectiveness of Clear Recovery Zones Nchrp Report 247," 1982.
http://onlinepubs.trb.org/Onlinepubs/nchrp/nchrp_rpt_247.pdf
19. National Cooperative Highway Research Program, "Nchrp Report 350," 1993.
20. D. Sicking, K. Mak, J. Rohde, and J. Reid, "Manual for Assessing Safety Hardware," *American Association of State Highway Transportation Officials, Washington DC*, 2009.
21. "Mash Implementation Deadlines Summary of Results by State," https://safety.fhwa.dot.gov/roadway_dept/countermeasures/reduce_crash_severity/results_by_state.cfm, [retrieved 5/25/2018].
22. Florida Department of Transportation, "Plans Preparation Manual," 2017.
23. "Design Standards Ebook 2016," <http://www.fdot.gov/roadway/DS/16/STDs.shtm>, [retrieved 5/25/2018].
24. California Department of Transportation Landscape Architecture, "Landscape Architecture Planting and Irrigation Plans, Specifications, and Estimates (Ps&E) Guide," 2008.
25. California Department of Transportation, "Plant Setback and Spacing Guide," 1997.
26. Arizona Department of Transportation, "Roadway Design Guidelines," pp, 2012.
27. California Department of Transportation, "Standard Specifications," 2006.
28. Nevada Department of Transportation, "Road Design Guide," pp, 2010.
29. Texas Department of Transportation, "Landscape and Aesthetics Design Manual," pp, 2017.
30. California Department of Transportation, "Roadside Management Toolbox," 2017.
31. Nevada Department of Transportation, "I-15 Landscape and Aesthetics Corridor Plan," pp, 2005.

Performance Measures for Roadside Features

32. South Carolina Department of Transportation, "Roadway Design Manual," 2017.
33. American Association of State Highway and Transportation Officials, "Highway Drainage Guidelines," **14**, 1973.
34. J.M. Normann, R.J. Houghtalen, and W.J. Johnston, "Hydraulic Design of Highway Culverts," 2001.
35. South Carolina Department of Transportation, "Requirements for Hydraulic Design Studies," pp, 2009.
36. California Department of Transportation, "Caltrans Storm Water Quality Handbook," pp, 2003.
37. Georgia Department of Transportation, "Stormwater System Inspection and Maintenance Manual," pp, 2015.
38. US Department of Transportation Federal Highway Administration, "Highway Traffic Noise Analysis and Abatement Guidance," pp, 2011.
39. Texas Department of Transportation, "Design Guide for Highway Noise Barriers," 2002.
40. California Department of Transportation, "Project Development Procedures Manual."
41. "Mutcds & Traffic Control Devices Information by State," https://mutcd.fhwa.dot.gov/resources/state_info/index.htm, [retrieved 5/20/2018].
42. US Department of Transportation Federal Highway Administration, "Standard Highway Signs," 2004.
43. California Department of Transportation, "California Sign Specification Drawings."
44. American Association of State Highway and Transportation Officials, "Standard Specifications for Structural Supports for Highway Signs, Luminaires, and Traffic Signals, 6th Edition," pp. 340, 2015.
45. South Dakota Department of Transportation, "Standard Specifications for Roads and Bridges," pp, 2015.
46. Iowa Department of Transportation, "Standard Specifications with Gs-15006 Revisions," pp, 2015.
47. California Department of Transportation, "Traffic Manual: Chapter 9."